

CITY OF DORAL



Invitation to Bid

ITB No. 2024-09

Construction of Section 7
Traffic Calming Improvements



**City of Doral
Invitation to Bid
Construction of Section 7 Traffic Calming Improvements
ITB No. 2024-09**

NOTICE: Pursuant to its Procurement Ordinance, the City of Doral (“City”) hereby gives notice of its intent to seek bids from interested and qualified parties in response to this Invitation to Bid (“ITB”) to provide the services described herein. Bids must be received no later than **July 30, 2024 at 2:00 PM.**

Bids must be submitted electronically through DemandStar <https://network.demandstar.com/> or Vendor Registry <https://vendorregistry.com/> by the date and time stated above. The responsibility for submitting a Bid before the stated time and date is solely and strictly that of the Proposer. The City is not responsible for any delayed, lost, late, misdelivered, or non-delivered Bids, no matter the cause. Any submittals received after the due date and time specified will not be considered.

This ITB is subject to the “Cone of Silence”. Accordingly, all questions and/or comments regarding this ITB must be made in writing and be directed to Procurement at the following email at procurement@cityofdoral.com. All inquiries must reference “**ITB No. 2024-09 Construction of Section 7 Traffic Calming Improvements**” in the subject line. No phone calls will be accepted in reference to this solicitation. If it becomes necessary to provide additional clarifying information that revises any part of this solicitation, supplements or revisions will be made available via written addendum.

Solicitations and addenda or notices in connection therewith may be downloaded from the City of Doral Procurement Division webpage under “[Active Solicitations](#)”, on [Vendor Registry](#), and on [Demand Star](#). To receive notifications of addenda or notices issued in connection with this ITB, interested parties must register on Vendor Registry or on Demand Star. The City reserves the right to reject any and all submissions, to waive any and all irregularities in any submission, to solicit and re-advertise for bids and to make awards in the best interest of the City, as determined in its sole discretion.

The City reserves the right to accept any submittals deemed to be in the best interest of the City, to waive any minor irregularities, scrivener’s errors, minor omissions, minor deviations, and/or technicalities in any Bids, or to reject any or all Bids and to re-advertise for new Bids, in accordance with the applicable sections of the Florida Statutes, the City Charter and Code, and this ITB. PROPOSERS ARE ADVISED THAT PROPOSALS OR BIDS SUBMITTED WITH IRREGULARITIES, DEFICIENCIES, AND/OR TECHNICALITIES THAT DEVIATE FROM THE MINIMUM SUBMISSION REQUIREMENTS OF THIS SOLICITATION SHALL RESULT IN A NON-RESPONSIVE DETERMINATION. ONLY MINOR IRREGULARITIES, DEFICIENCIES, AND TECHNICALITIES MAY BE ALLOWED TO BE TIMELY CURED BY PROPOSERS AT THE SOLE DISCRETION OF THE CITY. MATERIAL IRREGULARITIES, DEFICIENCIES, AND TECHNICALITIES CANNOT BE CURED BY THE PROPOSER/BIDDER.

PROJECT OVERVIEW

The City of Doral is soliciting Bids from a qualified General Engineering Construction Contractor to construct Section 7 traffic calming improvements. Through the Invitation to Bid (ITB) process described herein, qualified Contractors interested in assisting the City with the provision of such services must prepare and submit a bid packet in accordance with the procedure and schedule of this ITB.

One of the following licenses is required within the bid submittal package: State of Florida Certified Electrical Contractor, State of Florida Certified Underground Utility and Excavation Contractor, or a State Registered Electrical Contractor with license in Miami Dade County as issued by the CTQB. The City will review submittals only from those responsible and qualified Contractors that submit a responsive ITB packet which includes all the information required.

The City intends to award a contract in substantially the form attached as Exhibit B for the Section 7 Traffic Calming Improvements to the responsive and responsible Contractor that possesses qualified manpower, equipment, administrative capabilities, applicable experience, and provides the best price proposal to the City.

SCHEDULE

The City's schedule for this ITB is as follows:

Issuance/Advertisement Date:

Friday, June 28, 2024

Monday, Jul 8, 2024 at 10:00 AM

Non-Mandatory
Pre-Bid Conference:

Join from your computer, tablet or smartphone.

<https://meet.goto.com/582792157>

You can also dial in using your phone.

United States: +1 (571) 317-3122

Access Code: 582-792-157

Cut-off Date for Written
Questions:

Monday, July 15, 2024 at 10:00 AM

Deadline for Submittals &
Bid Opening:

Tuesday, July 30, 2024 at 2:00 PM

Submissions Due Electronically
via DemandStar or Vendor Registry

Join from your computer, tablet or smartphone.

<https://meet.goto.com/623562621>

United States: +1 (408) 650-3123

Access Code: 623-562-621

TABLE OF CONTENTS

ARTICLE 1 – GENERAL TERMS AND CONDITIONS.....7

1.1 Definitions7

1.2 Cone Of Silence7

1.3 Examination Prior to Submission8

1.4 Clarifications and Addenda8

1.5 Withdrawal of Response8

1.6 Right To Cancel or Reject Responses.....8

1.7 Protests.....8

1.8 Incurred Expenses8

1.9 Preparation of Response8

1.10 Submission of Responses & Evaluations9

1.11 Prohibition Against Considering Social, Political, or Ideological Interests9

1.12 Identical (Tie) Responses.....9

1.13 Public Records.....9

1.14 Compliance With Applicable Laws10

1.15 Public Entity Crime10

1.16 Equal Employment Opportunity.....10

1.17 Compliance with Occupational Health and Safety Act (OSHA) Standards.....10

1.18 Scrutinized Companies.....10

1.19 Fraud and Misrepresentation.....11

1.20 Collusion11

1.21 Respondent in Arrears or Default.....11

1.22 Conflict of Interest11

1.23 Assignment or Transfer.....11

1.24 City Property.....12

1.25 Termination For Default.....12

1.26 Termination For Convenience12

1.27 Confidentiality12

1.28 Anti-Trust/Non-Exclusivity.....12

1.29 Quantities12

1.30 Audit Rights and Records Retention12

1.31 Capital and Other Expenditures.....12

1.32 Governing Law and Venue.....13

1.33	Attorney Fees	13
1.34	Disputes	13
1.35	Waiver of Jury Trial	13
1.36	No Partnership or Joint Venture	13
1.37	Severability	13
1.38	Indemnification	13
1.39	City Rights as Sovereign	14
1.40	Time is of the Essence	14
1.41	Delivery	14
1.42	Brand Names	14
1.43	Contract Amendments	15
1.44	Conflicts and Order of Precedence	15
1.45	Contract Interpretation and Construction	15
1.46	Rights and Remedies	15
1.47	Inspection of Project Records	15
1.48	Notice	15
1.49	Payment	16
1.50	Taxes	16
1.51	Employees	16
1.52	Subcontractors or Suppliers	16
1.53	Extensions	16
1.54	Hiring Preference for Procured Projects	16
ARTICLE 2 – SPECIAL TERMS AND CONDITIONS		17
2.1	Bid Submittal Instructions	17
2.2	Basis of Award	17
2.3	Contract Timing	17
2.4	Project Schedule and Preparation	17
2.5	Identification of Subcontractors	17
2.6	Licensing	17
2.7	Bid Bond	17
2.8	Payment Bond, and Performance Bond	18
2.9	Insurance Requirements	17
2.10	Hours of Work	18
2.11	On-Site Survey/As Built	18

2.12	Permits	18
2.13	Public Convenience and Safety	18
2.14	Safety and Protection.....	19
2.15	Trench Safety Act.....	20
2.16	Emergencies.....	20
2.17	City’s Field Representative.....	20
2.18	Security	21
2.19	Work Site Conditions	21
2.20	Existing Utilities, Structures, & Facilities	21
2.21	Changes to the Work.....	22
2.22	Changes to the Contract Time or Price.....	22
2.23	Value Engineering Change Proposals.....	24
2.24	Suspension of Work and Termination.....	25
2.25	Payments and Completion.....	26
2.26	Testing & Inspections	26
2.27	Contractor’s General Warranty & Guarantee.....	28
2.28	Materials	29
2.29	Equipment.....	30
2.30	Water Usage.....	30
2.31	Staging	30
2.32	Liquidated Damages.....	30
ARTICLE 3 – SCOPE OF WORK / TECHNICAL SPECIFICATIONS.....		31
3.1	Purpose and Intent.....	31
3.2	Scope of Work.....	31
3.3	Qualifications	31
3.4	Additional Specifications	31
ARTICLE 4 – REQUIRED SUBMISSION FORMS		33
<u>EXHIBITS</u>		
EXHIBIT A – REQUIRED SUBMISSION FORMS		
EXHIBIT B – DRAFT CONTRACT		
EXHIBIT C – INSURANCE REQUIREMENTS		
EXHIBIT D – ADDITIONAL SPECIFICATIONS		
EXHIBIT E – ROADWAY PLAN & SIGNING AND PAVEMENT MARKING PLANS		
EXHIBIT F – ENGINEER’S OPINION OF PROBABLE COST		

ARTICLE 1 – GENERAL TERMS AND CONDITIONS

1.1 Definitions

“Authorized Representative” means the Department contact for interaction regarding contract administration.

“City” means the City of Doral, a duly organized municipality under the laws of the State of Florida. This term may also refer to one of the various departments or agencies of the City of Doral, as the context indicates.

“Contract” means the contractual agreement ultimately entered into by the City and the Successful Respondent(s) in accordance with the terms of this Solicitation and applicable laws.

“Department(s)” means the City department(s) and offices for which this solicitation is prepared, which will be the end user(s) of the goods and/or services sought.

“Procurement Division” means the office responsible for handling procurement-related matters within the City.

“Respondent(s)”: means any person, individual, or entity submitting a response to this solicitation. The terms “Proposer” and “Bidder” are each interchangeable with “Respondent” and with each other and will be used as appropriate in the given context.

“Response(s)” means the written, sealed document submitted by the Respondent(s) according to the instructions set forth in this Solicitation. A response to this Solicitation shall not include any verbal interactions with the City apart from submittal of a formal written submittal. The terms “Proposal” and “Bid” are each interchangeable with “Response” and with each other will be used as appropriate in the given context.

“Solicitation” means this formal request to solicit Responses from responsible and responsive Respondents for the scope and specifications set forth herein. The terms “Invitation to Bid”, “Request for Proposals”, “Request for Qualifications”, and the like are each interchangeable with “Solicitation” and will be used as appropriate in the given context.

“Successful Respondent(s)” means the Respondent(s) whose response to this Solicitation is deemed by the City to be in the City’s best interest and is awarded a contract in accordance with the terms of this Solicitation. The terms “Successful Proposer”, “Successful Bidder”, or “Contractor” are each interchangeable with “Successful Respondent” and will be used as appropriate in the given context.

“Work” means the actual task (i.e., good and/or services to be provided) contemplated by this Solicitation and required in accordance with the terms of the Contract.

1.2 Cone Of Silence

This Solicitation shall be subject to the “Cone of Silence” which shall mean a prohibition on any communication regarding a Solicitation between potential Respondent(s) or their lobbyists or representatives and the City Council, City staff including, but not limited to, the City Manager and his or her staff, and any member of the City’s selection or evaluation committee, except as otherwise explicitly provided herein.

The Cone of Silence shall be imposed upon this Solicitation after the advertisement thereof and shall terminate upon the issuance of the City Manager’s recommendation to award. However, if the City Council refers the City Manager’s recommendation back to the City Manager or committee for further review, the Cone of Silence shall be re-imposed until such time a recommendation is issued by the City Manager after such additional review.

The Cone of Silence shall not apply to:

- Communications with the City Attorney;
- Oral presentations before evaluation committees;
- Public presentations made to the City Council during any duly noticed public meeting;
- Written communications regarding a particular Solicitation between a potential Respondent, and the City’s Procurement Division, provided the communication is limited strictly to matters of process or procedure already contained in the Solicitation;
- Duly noticed site visits to determine the competency of bidders/Respondent(s) regarding a particular bid/proposal during the time period between the opening of bids and the time the City Manager makes his or her written recommendation;
- Any emergency procurement of goods or services pursuant to City Code;
- Responses to the City’s request for clarification or additional information;
- Contract negotiations during any duly noticed public meeting;
- Communications to enable City staff to seek and obtain industry comment or perform market research, provided all communications related thereto are in writing or made at a duly noticed public meeting.

Please contact the City Attorney for any questions concerning Cone of Silence compliance. Violation of the Cone of Silence by a Respondent shall render any award of this Solicitation to said Respondent voidable by the City Manager or Council.

1.3 Examination Prior to Submission

Respondents must thoroughly examine each section. If there is any doubt or obscurity as to the meaning of any part of this Solicitation, Respondents may request clarification by written request to the Procurement Division.

Respondents are required to be familiar with any conditions that may, in any manner, affect the Work to be done or affect the equipment, materials, or labor required. Respondents are also required to carefully examine the specifications and all equipment and all site locations and be thoroughly informed regarding all conditions that may, in any manner, affect the Work to be performed under the Contract. By submission of a Response, it will be construed that the Respondent is acquainted sufficiently with the site(s) and work to be performed.

1.4 Clarifications and Addenda

Questions regarding this Solicitation shall be directed in writing by email to the Procurement Division at the email address specified in this Solicitation. Answers will be issued simultaneously to all registered Respondents. If it becomes evident that this Solicitation must be amended, the City will issue a formal written addendum to all registered Respondent(s) via email or through Vendor Registry and Demand Star. The addendum will be uploaded to the City's Procurement webpage.

No person is authorized to give oral interpretations of, or make oral changes to, the Solicitation. The issuance of a written addendum shall be the only official method whereby such a clarification is made. Only questions answered by written addenda shall be binding.

1.5 Withdrawal of Response

A Respondent(s) may, without prejudice, withdraw, modify, or correct the Response after it has been submitted to the City, provided the request and any subsequent modifications and/or corrections are filed with the City in writing before the deadline to submit the Response. The original Response as modified by such writing will be considered as the Response submitted by the Respondent(s). No oral modifications will be considered.

1.6 Right To Cancel or Reject Responses

The City reserves the right to cancel this Solicitation or reject any and/or all Responses or portions thereof, and to waive any technicalities or minor irregularities. Each Respondent agrees to hold harmless and covenant not to sue the City, its officials, officers, or employees, for any claims arising out of or in connection with the administration, evaluation, recommendation, or rejection of Responses.

The City does not bind itself to accept the minimum specifications stated herein, but reserves the right to accept any Response, which, in the sole judgment of the City, will best serve the needs and interests of the City. This issuance of this Solicitation itself does not in any way constitute a contractual agreement between the City and the Respondent(s) unless and until the City awards the Solicitation, obtains all required approvals, and executes a Contract in accordance herewith. Furthermore, the City reserves the right to award without further discussion.

The City also reserves the right to award the Contract on a split order basis, group by group, or item by item, or such combination as will best serve the interests of the City, unless otherwise stated.

1.7 Protests

Protests of Solicitations and awards shall be submitted and resolved pursuant to City Code Section 2-338. Protests failing to meet all the requirements for filing shall NOT be accepted. Failure of a party to timely file shall constitute a forfeiture of such party's right to file a protest. NO EXCEPTIONS WILL BE MADE TO THIS REQUIREMENT.

1.8 Incurred Expenses

The City shall not be responsible for any expenses incurred by any of the Respondents for the preparation of their Responses to this Solicitation, or for any associated costs in relation thereto, including without limitation the cost incurred during any presentation or negotiations related to potential award.

1.9 Preparation of Response

Responses should be prepared simply and economically, providing a straightforward, concise description of the Respondent's ability to fulfill the requirements of the Solicitation.

Responses shall include all of the information and forms required by this Solicitation. Failure to utilize the City's forms, or fully complete said forms, may result in the

Response being deemed non-responsive. The Respondent shall be considered non-responsive if its Response is conditioned on modifications, changes, or revisions to the terms and conditions of the Solicitation.

1.10 Submission of Responses & Evaluations

Acknowledgment by Respondent: By submitting a Response, the Respondent certifies that he/she has fully read and understands the Solicitation and has full knowledge of the scope, nature, and quality of services to be performed or goods to be provided. Incomplete, unresponsive, irresponsible, vague, or ambiguous responses to the Solicitation will be cause for rejection, as determined in the sole discretion of the City.

Acceptance/Rejection/Modification: The City reserves the right to negotiate modifications to proposals that it deems acceptable, reject any and all proposals, and to waive minor irregularities in the submittals.

Postponement of Response Opening: The City reserves the right to postpone the date for receipt and opening of Response submissions and will make a reasonable effort to give at least three (3) calendar days' notice, whenever practicable, of any such postponement to prospective Respondents.

Responses Binding: All Responses submitted in connection with this Solicitation shall constitute binding offers to the City for one hundred and eighty (180) calendar days after opening.

Alternate Responses: An alternate Response shall not be considered or accepted by the City.

Interviews: The City reserves the right to conduct interviews or require presentations prior to award.

Samples: When required by this Solicitation, samples of any goods proposed to be provided by Successful Respondent must be furnished to the City free of charge. Materials or equipment for which samples are required shall not be used in work until approved by the City. Each sample must be labeled with the Respondent's name and delivered within ten (10) calendar days of the Solicitation opening unless another timeframe is specified in this Solicitation. If samples are requested after the Solicitation opening, they should be delivered within ten (10) calendar days of the request. The City will not be responsible for returning samples. Acceptance or approval of a sample shall not be construed to change or modify any Contract requirements.

Inspections: The City, at its sole discretion, reserves the

right to inspect Respondent's facilities or products, as applicable, to determine their capability of meeting the requirements for the Contract.

Proprietary Responses: By submitting a Response, the Respondent acknowledges that the Response will become the property of the City and will not be returned to the Respondents. In the event of Contract award, all documentation produced as part of the Contract will become the exclusive property of the City.

1.11 Prohibition Against Considering Social, Political, or Ideological Interests

Respondents are hereby notified of the provisions of Section 287.05701, Florida Statutes, as amended, which provides that the City will not request documentation of or consider a Respondent's social, political, or ideological interests when evaluating Respondent's responsibility. Respondents are further notified that the City Council will not give preference to Respondents based on their social, political, or ideological interests.

1.12 Identical (Tie) Responses

Responses that are evaluated as being equal with respect to price, quality, and service for the procurement of commodities or contractual services (sometimes referred to herein as "Tie Bids"), received from a business that certifies that it has implemented a drug-free workplace program shall be given preference in the award process provided the Respondent complies with the requirements of Section 287.087, Florida Statutes.

1.13 Public Records

This Solicitation and any Responses or other information provided by Respondents in connection therewith, including but not limited to any subsequent Contract, shall be subject to the provisions of Chapter 119, Florida Statutes ("Public Records Law"). Responses are exempt from public disclosure until the City provides notice of an intended decision or until 30 days after opening the Responses, whichever occurs earlier.

By submitting a Response, Respondent(s) acknowledges that the Response, the materials submitted with the Response, the results of the City's evaluation and the subsequent Contract are open to public inspection upon proper request unless explicitly exempt under Florida law. Respondent(s) should take special note of this as it relates to proprietary information that might be included in its Response.

In the event that a Respondent submits information to the City that is proprietary or otherwise exempt from the

Public Records Law, such Respondent shall explicitly indicate the information that is exempt from public disclosure and shall provide reasons therefor and shall identify the applicable exemption with a reference to the applicable law allowing for the exemption. The City reserves the right to make any final determination on the applicability of the Public Records Law.

1.14 Compliance With Applicable Laws

Successful Respondent(s) shall comply with all local, state, and federal directives, ordinances, rules, orders, and laws as applicable to this Solicitation and subsequent Contract. Lack of knowledge by the Respondent(s) will in no way be a cause for relief from responsibility. Respondents must be legally authorized to transact business in the State of Florida.

Non-compliance with all local, state, and federal directives, orders, and laws may be considered grounds for termination of contract(s). If the Successful Respondent(s) observes that the Response or subsequent Contract are at variance with applicable laws, Successful Respondent(s) will give the City prompt written notice thereof. If the Successful Respondent(s) performs knowing it to be contrary to such laws, ordinances, rules, and regulations, such Successful Respondent(s) will bear all liability arising wherefrom.

In the event that any governmental restrictions are imposed that would necessitate alteration of the goods or services requested by this Solicitation and/or offered by the Successful Respondent prior to delivery or completion, it shall be the responsibility of the Respondent(s) to notify the City immediately. In the event the City determines that the alteration diminishes the City's bargained-for exchange or frustrates the project, the City reserves the right to accept the alteration or cancel the Contract.

1.15 Public Entity Crime

A person or affiliate who has been placed on the convicted vendor list following a conviction for a public entity crime may not submit a Response on a contract to provide any goods or services to a public entity, may not submit a Response on a contract with a public entity for the construction or repair of a public building or Public Works project, may not submit a Response on a lease of real property to a public entity, may not be awarded or perform work as a contractor, supplier, subcontractor, or consultant under a contract with any public entity, and may not transact business with any public entity in excess of the threshold amount provided in Section 287.017, Florida Statutes for Category Two for a period

of thirty-six (36) months from the date of being placed on the convicted vendor list, as defined in Section 287.133, Florida Statutes.

1.16 Equal Employment Opportunity

The Respondent shall comply with Title VII of the Civil Rights Act of 1964 42 U.S.C. Section 2000e et seq., Section 504 of the Rehabilitation Act of 1973 29 U.S.C. Section 701 et seq., and Title I of the Americans with Disabilities Act, 42 U.S.C. Section 12101 as of 1990 in that: No person in the United States shall on the grounds of race, creed, color, national origin, sex, age, political affiliation, beliefs or disability be subject to discrimination under any program or activity which the Respondent has agreed to undertake by and through the covenants, and provisions set forth in this Contract.

1.17 Compliance with Occupational Health and Safety Act (OSHA) Standards

Respondent certifies that all materials, equipment, etc., contained in its Response meet all OSHA requirements. Respondent further certifies, that, if he/she is the Successful Respondent, and the materials, equipment, etc., delivered are subsequently found to be deficient in any OSHA requirement in effect on the date of use, all costs necessary to bring the materials equipment, etc., into compliance with the aforementioned requirements shall be borne solely the Successful Respondent. Upon request the contractor shall provide the City with a copy of their written safety program pertaining to the subject of the Contract, if such a program is required by law.

The Successful Respondent shall be solely and completely responsible for conditions of the job site, including safety of all persons (including employees) and property during performance of the work. This requirement shall apply continuously and not be limited to normal working hours. Safety provisions shall conform to the U.S. Department of Labor OSHA, Florida Department of Labor, and all other applicable federal, state, county, and local laws, ordinances, codes, and regulations. Where any of these are in conflict, the more stringent requirement shall be followed.

1.18 Scrutinized Companies

Respondent must certify that it is not participating in a boycott of Israel and must also certify that it is not on the Scrutinized Companies that Boycott Israel list, not on the Scrutinized Companies with Activities in Sudan List, and not on the Scrutinized Companies with Activities in the Iran Petroleum Energy Sector List. Contractor must submit the certification that is attached to this agreement. Submitting a false certification shall be

deemed a material breach of contract. The City shall have the right to terminate the Contract and seek civil remedies pursuant to Florida Statute § 287.135.

1.19 Fraud and Misrepresentation

Any individual, corporation, or other entity that attempts to meet its contractual obligations with the City through fraud, misrepresentation, or material misstatement, or omission of any material fact, may be debarred in accordance with the applicable provisions of the City Code. The City as a further sanction may terminate or cancel any other Contracts with such individual, corporation, or entity. Such individual or entity shall be responsible for all direct or indirect costs associated with termination or cancellation.

1.20 Collusion

Where two (2) or more related parties, as defined herein, each submit a Response to this Solicitation, such Responses shall be presumed to be collusive. The foregoing presumption may be rebutted by the presentation of evidence as to the extent of ownership, control, and management of such related parties in preparation and submission under such solicitation. Related parties shall mean employees, officers or the principals thereof which have a direct or indirect ownership interest in another firm or in which a parent company or the principals thereof of one Respondent have a direct or indirect ownership interest in another Respondent, for the same Project. Responses found to be collusive, or related as provided above, shall be rejected.

1.21 Respondent in Arrears or Default

The Respondent represents and warrants that the Respondent is not in arrears to the City, City agency, or instrumentality, and is not a default as a Contractor, Vendor, Provider or whose default has not been fully cured by the Respondent's surety or otherwise upon any obligation to the City. In addition, the Respondent warrants that the Bidder has not been declared "not responsible" or "disqualified" by, suspended, or debarred from doing business with any state or local government entity in the State of Florida, the Federal Government or any other State/local governmental entity in the United States of America, nor is there any proceeding pending pertaining to the Respondent's responsibility or qualifications to receive public agreements. The Respondent considers this warrant as stated in this section to be a continual obligation and shall inform the City of any change during the term of the Contract.

The City shall deem as non-responsible, Respondents

that the City has determined is in monetary arrears, in debt, or in default to the City at the time bids are due.

1.22 Conflict of Interest

By way of its Response, Successful Respondent recognizes and certifies that no elected official, board member, or employee of the City shall have a financial interest directly or indirectly in the Contract or any compensation to be paid under or through this transaction, and further, that no City employee, nor any elected or appointed officer (including City Council members) of the City, nor any spouse, parent or child of such employee or elected or appointed officer of the City, may be a partner, officer, director or proprietor of Respondent, and further, that no such City employee or elected or appointed officer, or the spouse, parent or child of any of them, alone or in combination, may have a Material Interest in the Respondent. "Material Interest" for purposes of this subsection shall mean direct or indirect ownership of more than 5% of the total assets or capital stock of the Respondent. Any exception to these above-described restrictions must be expressly provided by applicable law or ordinance and be confirmed in writing by City. Further, Respondent recognizes that with respect to its Response to this Solicitation, if any Respondent violates or is a party to a violation of the ethics ordinances or rules of the City, the provisions of Miami- Dade County Code Section 2-11.1, as applicable to City, or the provisions of Chapter 112, part III, Fla. Stat., the Code of Ethics for Public Officers and Employees, such Respondent may be disqualified from furnishing the goods or services for which the Response is submitted and may be further disqualified from submitting any future Responses for goods or services to City. Respondent must complete and execute the Business Entity Affidavit form.

1.23 Assignment or Transfer

The Successful Respondent shall not assign, transfer, convey, sublet or otherwise dispose of its interest in the Solicitation or the subsequent Contract, including any or all of its right, title or interest therein, or its power to execute such Contract to any person, company or corporation without the prior written consent of the City at its sole and absolute discretion.

Further, in the event that the majority ownership or control of the Successful Respondent changes subsequent to the award of this Solicitation or Contract, Successful Respondent shall promptly notify City in writing of such change at least thirty (30) days prior to such change and the City shall have the right to terminate the contract, at City's sole discretion.

1.24 City Property

Unless explicitly provided otherwise in this Solicitation, property owned by the City which may be furnished for repair, modification, study, etc., shall remain the property of the City. The Successful Respondent shall be liable for any and all damages to City-owned property occurring while in the Successful Respondent's possession. Damages occurring to such property while in route to the City shall be the responsibility of the Successful Respondent. In the event that such property is destroyed or declared a total loss, the Successful Respondent shall be responsible for replacement value of the property at the current market value, less depreciation of the property if any plus any other damages incurred by the City as a result of such loss.

Where Successful Respondents are required to enter onto City real property to deliver materials or to perform work or services in connection with a Contract, the Successful Respondent will assume the full duty, obligation, and expense of obtaining all necessary licenses, permits, inspections, and insurance required. The Successful Respondent shall be liable for any damages or loss to the City occasioned by negligence of the Successful Respondent (or their agent, representatives, or invitees).

1.25 Termination For Default

If the Successful Respondent defaults in its performance under the Contract and does not cure the default within thirty (30) days after written notice of default, the City Manager may terminate this Contract, in whole or in part, upon written notice without penalty to the City. In such event, the Successful Respondent shall be liable for damages including the excess cost of procuring similar supplies or services: provided that if, (1) it is determined for any reason that the Successful Respondent was not in default or (2) the Successful Respondent's failure to perform is without his control, fault or negligence, the termination will be deemed to be a termination for the convenience of the City.

1.26 Termination For Convenience

The City Manager may terminate the Contract, in whole or in part, upon 30 days prior written notice when it is in the best interests of the City. If the Contract is for supplies, products, equipment, or software, and so terminated for the convenience by the City, the Successful Respondent will be compensated solely for the supplies, products, equipment, or software that have been delivered to and accepted by the City prior to termination. To the extent that this Contract is for services and so terminated, the City of Doral shall be

liable only for payment in accordance with the payment provisions of the Contract for those services rendered prior to termination. Except as expressly provided herein, the City shall not be liable for any damages incurred by the counterparty to the Contract in connection with such termination.

1.27 Confidentiality

As a political subdivision, the City is subject to the Florida Sunshine Act and Public Records Law. If the Contract contains a confidentiality provision, it shall have no application when disclosure is required by Florida law or upon court order.

1.28 Anti-Trust/Non-Exclusivity

At such times as may serve its best interest, the City reserves the right to advertise for, receive, and award additional Contracts for the goods and/or services specified in this Solicitation, and to make use of other contracts for the purchase of these goods and/or services as may be available.

In case of a default by the Successful Respondent or failure of Successful Respondent to provide the goods and/or services indicated in the Contract, the City may procure the applicable goods and/or services from other sources and hold the Successful Respondent responsible for any excess costs incurred thereby, including, without limitation and as applicable, by retaining any amounts held by the City.

1.29 Quantities

The City does not guarantee or warranty as to the total amount that may or may not be purchased from any resultant Contract. Any quantities included are for bidding purposes only and will be used for tabulation and presentation. The City reserves the right to reasonably increase or decrease quantities as required.

1.30 Audit Rights and Records Retention

The Successful Respondent agrees to provide access to the City, or any of their duly authorized representatives, to any books, documents, papers, and records of the Successful Respondent which are directly pertinent to the Contract, for the purposes of audit, examination, excerpts, and transcriptions. The Successful Respondent shall maintain and retain any and all of the aforementioned records for a minimum of three years after the expiration and/or termination of the Contract.

1.31 Capital and Other Expenditures

Successful Respondent understands that any capital expenditures that the Successful Respondent makes, or

prepares to make, in order to provide the goods or perform the services required by the City under the Contract, is a business risk which the Successful Respondent must assume. The City will not be obligated to reimburse amortized or unamortized capital expenditures or any other expenses unless otherwise explicitly agreed to by the City in writing and as part of the Contract.

1.32 Governing Law and Venue

The validity and effect of the Contract shall be governed by the laws of the State of Florida. The Successful Respondent agrees that any action, mediation, or arbitration arising out of the Solicitation or Contract shall take place in Miami-Dade County, Florida.

1.33 Attorney Fees

In connection with any litigation, mediation, or arbitration arising out of this Contract, each party shall be responsible for their own attorney fees through and including appellate litigation and any post-judgment proceedings.

1.34 Disputes

If any dispute concerning a question of fact arises under the Contract, other than termination for default or convenience, the Successful Respondent, and the City department responsible for the administration of the Contract shall make a good faith effort to resolve the dispute. If the dispute cannot be resolved by mutual agreement, then the City Manager shall resolve the dispute and send a written copy of its decision to the Successful Respondent, which shall be binding on both parties.

1.35 Waiver of Jury Trial

The City and the Successful Respondent knowingly, irrevocably voluntarily and intentionally waive any right either may have to a trial by jury in State or Federal Court proceedings in respect to any dispute arising out of the Contract or the performance of the Work thereunder.

1.36 No Partnership or Joint Venture

Nothing contained in this Solicitation or Contract will be deemed or construed to create a partnership or joint venture between the City and Successful Respondent, or to create any such relationship between the parties.

The Successful Respondent is an independent entity under the Contract. Services provided by the Successful Respondent shall be by employees of the Successful Respondent and subject to supervision by the Successful Respondent, and not as officers, employees,

or agents of the City. Personnel policies, tax responsibilities, social security and health insurance, employee benefits, purchasing policies and other similar administrative procedures, applicable to services rendered under the Contract shall be those of the Successful Respondent.

1.37 Severability

If any provision of the Contract or the application thereof to any person or situation shall to any extent, be held invalid or unenforceable, the remainder of the Contract, and the application of such provisions to persons or situations other than those as to which it shall have been held invalid or unenforceable shall not be affected thereby, and shall continue in full force and effect, and be enforced to the fullest extent permitted by law.

1.38 Indemnification

The Successful Respondent granted a Contract with the City as a result of this Solicitation shall indemnify and hold harmless the City, its officers, agents, directors, and employees, from liabilities, damages, losses, and costs, including, but not limited to all reasonable attorney's fees and costs, to the extent caused by the error, omission, negligence, recklessness or intentional misconduct of the Successful Respondent or its agents, employees, or subcontractors or consultants, arising out of or in connection with this Solicitation or the Contract. These indemnifications shall survive the term of the Contract. In the event that any action or proceeding is brought against City by reason of any such claim or demand, the Successful Respondent shall, upon written notice from City, resist and defend such action or proceeding by counsel satisfactory to City. The Successful Respondent expressly understands and agrees that any insurance protection required by this Contract or otherwise provided by the Successful Respondent shall in no way limit the responsibility to indemnify, keep and save harmless and defend the City or its officers, employees, agents and instrumentalities as herein provided.

The indemnification provided above shall obligate the Successful Respondent to defend at its own expense to and through appellate, supplemental or bankruptcy proceeding, or to provide for such defense, at City's option, any and all claims of liability and all suits and actions of every name and description which may be brought against City whether performed by the Successful Respondent or persons employed or utilized by the Successful Respondent. This indemnity will survive the cancellation or expiration of the Contract.

This indemnity will be interpreted under the laws of the

State of Florida, including, without limitation, in a manner that conforms to the limitations of §768.28, §725.06 and/or §725.08, Florida Statutes, as applicable and as amended.

The Successful Respondent shall require all subconsultants and subcontractors' agreements to include a provision specifying that they will indemnify and hold harmless the City in the manner substantially set forth above.

The Successful Respondent agrees and recognizes that the City shall not be held liable or responsible for any claims which may result from any actions or omissions of the Successful Respondent in which the City participated either through review or concurrence of the Successful Respondent's actions. In reviewing, approving or rejecting any submissions by the Successful Respondent or other acts of the Successful Respondent, the City in no way assumes or shares any responsibility or liability of the Successful Respondent or subcontracted entities, under the Contract.

Successful Respondent warrants that there has been no violation of copyrights or patent rights in submitting their Response or providing the goods or services requested by this Solicitation. The Successful Respondent shall pay all royalties and assume all costs arising from the use of any invention, design, process materials, equipment, product or device which is the subject of patent rights or copyrights. Successful Respondent shall, at its own expense, hold harmless and defend the City against any claim, suit or proceeding brought against the City which is based upon a claim, whether rightful or otherwise, that the goods or services, or any part thereof, furnished under the contract, constitute an infringement of any patent or copyright of the United States. The Successful Respondent shall pay all damages and costs awarded against the City.

1.39 City Rights as Sovereign

Notwithstanding any language contained in this Solicitation or subsequent Contract, Successful Respondent understands that the City retains all of its sovereign prerogatives and rights as a municipality under applicable laws, including, but not limited to, any regulatory authority and approvals. Neither the issuance of this Solicitation nor any subsequent Contract shall constitute a waiver of the City's rights as sovereign. In no event shall the City have any obligations or liabilities to the Successful Respondent under the Contract or otherwise on account of the City's exercise of its sovereign prerogatives and rights and regulatory

authority (quasi-judicial or otherwise) as a municipal government.

1.40 Time is of the Essence

Successful Respondent understands and agrees that time is of the essence in the completion and delivery of the goods and/or services to be provided in connection with the Solicitation and subsequent Contract.

Contractor will promptly perform its duties under the Contract and will give the Work as much priority as is necessary to cause the Work to be completed on a timely basis in accordance with the Contract. All Work shall be performed strictly (not substantially) within the time limitations necessary to maintain the critical path and all deadlines established in the Contract. Time is of the essence in performance of the Work.

1.41 Delivery

The delivery of any all goods required by this Solicitation and resultant Contract shall be delivered F.O.B. Destination (i.e., at a specific City-designated address), and delivery costs and charges (if any) will be included in the quoted price. Exceptions shall be noted.

Goods or material(s) delivered to the City pursuant to this Solicitation and resultant Contract shall remain the property of the Successful Respondent until accepted to the satisfaction of the City. In the event goods or materials delivered to City are found to be defective or do not conform to specifications, the City reserves the right to reject or return the same to the Successful Respondent at the Successful Respondent's expense. Rejected goods left longer than thirty (30) calendar days will be regarded as abandoned and the City shall have the right to dispose of them as its own property. Rejection for non-conformance or failure to meet delivery schedules may result in the Contractor being found in default.

1.42 Brand Names

Unless otherwise provided in this Solicitation, if a brand name, make, manufacturer trade name, or vendor catalog is mentioned, whether followed by the words "approved equal" or otherwise, it is the intent of the City that such name is included for the purpose of establishing a grade or quality of material only. Bidder may offer alternatives of equal quality and appropriateness for the City's needs with appropriate identification, samples, and/or specifications. The City shall be the sole judge concerning the merits of items as equals.

1.43 Contract Amendments

The Contract(s) that result from this Solicitation may not be modified except pursuant to written amendment executed by both the City and the Successful Respondent, or their authorized successors or assigns.

1.44 Conflicts and Order of Precedence

This Solicitation and Contract shall be read together to avoid any conflicts. However, in the event of a conflict or inconsistency between this Solicitation or any exhibit attached hereto, any document referred to herein, or any document incorporated into this Solicitation and Contract by reference, and a term, statement, requirement, the Response by Successful Respondent, specifications and plans prepared by the Successful Respondent, if applicable, or provision of the Contract the following order of precedence shall apply:

In the event of any conflicts between the Contract and Solicitation, the Contract, as may be amended, shall govern. Where there appears to be a conflict between the General Terms and Conditions, Special Terms and Conditions, the Technical Specifications, or any addendum issued, the order of precedence shall be the last addendum issued, the Technical Specifications, the Special Terms and Conditions, and then the General Terms and Conditions.

In the event of conflicts within the Contract, as amended the priorities stated below shall govern, as applicable:

- Scope of Work and Specifications shall govern over the Response, including without limitation any plans and drawings submitted thereby;
- Larger scale drawings shall govern over smaller scale drawings;
- Figured or numerical dimensions shall govern over dimensions obtained by scaling; and
- Where provisions of codes, manufacturer's specifications or industry standards are in conflict, the more restrictive or higher quality shall govern.

1.45 Contract Interpretation and Construction

The singular includes the plural, and the plural includes the singular. "Shall" is mandatory and "may" is permissive. The masculine gender includes the feminine and neuter. The words "furnish" and "furnish and install", "install", and "provide" or words with similar meaning shall be interpreted, unless otherwise specifically stated, to mean "furnish and install complete in place and ready for service".

Miscellaneous items and accessories which are not explicitly mentioned, but which are essential to produce

a complete and properly operating product providing the function indicated, shall be furnished and installed without change in the Contract price. Such miscellaneous items and accessories shall be of the same quality standards, including material, style, finish, strength, class, weight, or other applicable characteristics as specified for the major component of which the miscellaneous item or accessory is an essential part, and shall be approved by the City before installation. The above requirement is not intended to include major components not covered by or inferable from the Response and Contract specifications.

1.46 Rights and Remedies

The duties and obligations imposed by this Solicitation and Contract and the rights and remedies available thereunder, and, in particular but without limitation, the warranties, guarantees and obligations imposed upon Successful Respondent and those rights and remedies available to the City, shall be in addition to, and shall not be construed in any way as a limitation of, any rights and remedies available by law, by special guarantee or by other provisions of the Contract.

1.47 Inspection of Project Records

The City shall have the right to inspect and copy during regular business hours at City's expense, the books and records and accounts of Successful Respondent which relate in any way to the Contract, and to any claim for additional compensation made by Successful Respondent, and to conduct an audit of the financial and accounting records of Successful Respondent, which arise out of the Contract. Successful Respondent shall retain and make available to City all such books and records and accounts, financial or otherwise, which relate to the Contract and to any claim for a period of three (3) years following final completion of the underlying project at no cost to the City. During the implementation of the work contemplated under the Contract and the three (3) year period following final completion of the same, the Successful Respondent shall provide the City access to such books and records upon five (5) days written notice.

1.48 Notice

Whenever any provision of the Contract requires the giving of written notice it shall be deemed to have been validly given if delivered in person to the individual or to a member of the firm or to an officer of the corporation for whom it is intended, or if delivered at or sent by registered or certified mail, postage prepaid, to the last business address known to them who gives the notice.

1.49 Payment

The City as a municipal corporation is subject to the Local Government Prompt Payment Act, Chapter 218, Part VII, Fla. Stat., as amended. Payments made by the City shall not preclude the City from disputing any items or services billed under this Contract and shall not be construed as waiver or acceptance of any part of the goods or services.

1.50 Taxes

The cost of all applicable sales, use, and other taxes for which Respondent is liable under the Contract shall be included in the prices quoted provided by Respondent.

1.51 Employees

Successful Respondent shall be responsible for the appearance of all working on-site personnel assigned to the work in connection with the Contract (clean and appropriately dressed at all times). On-site personnel always supply proper identification upon request.

All employees of the Successful Respondent shall be considered to be at all times the sole employees of the Successful Respondent, under the Successful Respondent's sole direction, and not an employee or agent of the City. The Successful Respondent shall supply competent, suitably qualified, and capable employees and the City may require the Successful Respondent to remove any employee it deems careless, incompetent, insubordinate or otherwise objectionable and whose presence on City property is not in the best interest of the City. The City shall not have any duty to implement or enforce such requirements.

Each employee of the Successful Respondent shall be a citizen of the United States or an alien who has been lawfully admitted for permanent residence as evidenced by an Alien Registration Card. The Successful Respondent agrees not to employ any person undergoing sentence of imprisonment except as otherwise provided by applicable laws.

1.52 Subcontractors or Suppliers

Prior to the commencement of any work pursuant to the Contract, the Successful Respondent shall furnish, in writing to the City, the names of all persons/entities (including those who are to furnish materials or equipment fabricated to a special design), if any, proposed for each principal portion of the work. The City shall notify the Successful Respondent, in writing, of any proposed person or entity to which City has an objection. The Successful Respondent will not employ any subcontractor or supplier against whom the City may

have reasonable objection. Nor will the Successful Respondent be required to employ any subcontractor or supplier who has been accepted by the City, unless the City determines that there is good cause for doing so or if the terms of this Solicitation or Contract specify otherwise.

The Successful Respondent shall be fully responsible for all acts and omissions of their subcontractors and/or suppliers and of persons and organizations directly or indirectly employed by them and of persons and organizations for whose acts any of them may be liable to the same extent that they are responsible for the acts and omissions of persons directly employed by them.

All work performed for the Successful Respondent by a subcontractor, supplier, or other person will be pursuant to an appropriate agreement between the Successful Respondent and such person. All agreements between the Successful Respondent and all subcontractors, suppliers, or others shall specifically bind the subcontractor, supplier, or other person to all applicable terms and conditions of the Contract for the City' benefit. Nothing in the Contract shall create any contractual obligation or liability on the part of the City to any subcontractor, supplier, or other person having a direct contract with Successful Respondent, including without limitation any payment to any such person, except as may otherwise be required by law.

1.53 Extensions

The City reserves the right to automatically extend the Contract for up to one hundred twenty (120) calendar days beyond the stated contract term in order to provide City departments with continual service and supplies while a new contract is being solicited, evaluated, negotiated and/or awarded. If the right is exercised, the City shall notify the Contractor, in writing, of its intent to extend the Contract at the same price, terms and conditions for a specific number of days. Additional extensions over the first one hundred twenty (120) day extension may occur, if, the City and the Contractor are in mutual agreement of such extensions.

1.54 Hiring Preference for Procured Projects

To the extent applicable, Successful Respondent shall comply with the provisions of City Code Section 2-325, providing a preference for Doral Businesses and Residents in Public Works and Improvements Contracts unless otherwise prohibited by applicable law or grant requirement.

[END OF SECTION]

ARTICLE 2 – SPECIAL TERMS AND CONDITIONS

2.1 Bid Submittal Instructions

Bids must be submitted in the format and on the forms provided by this Solicitation as Exhibit A. Bids must be typed or printed in black or blue ink only. Use of erasable ink is not permitted. All corrections must be initialed. Any information to be submitted as part of the response may be attached behind the required forms. Responses by corporate entities must be executed in the corporate name by the President or other corporate officer accompanied by evidence of authority to sign. The corporate address and state of incorporation must be shown below the signature. Proposals by partnerships must be executed in the Partnership name and signed by a partner, whose title must appear under the signature and the official address of the partnership must be shown below the signature.

2.2 Basis of Award

Bids shall be on a unit price basis. Award of this Contract will be made to the lowest responsive and responsible bidder who bids on all items and whose bid offers the lowest total project cost when all items are added in the aggregate as indicated in the Bid Price Sheet. Failure to bid on all items shall deem your bid non-responsive. Additionally, the City shall give preference to a responsive and responsible bidder that is a certified veteran business enterprise in accordance with the provisions set forth in City Code Section 2-324(2)(a).

2.3 Contract Timing

The Contract will commence on the date the Agreement is executed by the City and Contractor and will continue to run consecutively for the period of one hundred and eighty (180) calendar days after date specified in Notice to Proceed. Project shall be completed and ready for final payment in accordance with the Contract Documents within one hundred and eighty (180) calendar days after the date specified in the Notice to Proceed ("Final Completion"). No extension of time will be given unless previously provided by the City Manager or designee in writing. Liquidated damages will be assessed for each calendar day for which completion of the project is delayed.

2.4 Project Schedule and Preparation

The Contractor shall start to perform their obligations under the Contract Documents on the date stipulated in the Notice to Proceed (NTP) for each site. No Work shall be done at the site prior to the date on which the NTP

commences to run, except with the written consent of the City. No work will be done on Saturday without written consent of the CITY or after the end of a normal business day unless prior approval is given by the City in writing. No work shall be permitted on Sundays or on national holidays.

Before undertaking each part of the Work, the Contractor shall carefully study and compare the Contract Documents and check and verify pertinent figures shown thereon and all applicable field measurements which shall be approximate. Any modifications to the proposed work, once construction has begun, will be at no cost to the City.

All Work completed under the Contract will be measured by the City according to the United States Standard Measures. All linear surface measurements will be made horizontally or vertically as required by the item measured.

2.5 Identification of Subcontractors

Bidders shall list all proposed subcontractors in the appropriate portion of the Required Submission Forms attached as Exhibit A. Contractor shall be responsible for the coordination of the trades, Subcontractors, materials and staff necessary to complete the Work.

2.6 Licensing

Respondents must have the proper license(s) and certification(s) to perform the Work being requested. Successful Respondent must provide a copy of their occupational/business license and State registration at time of award. Failure to possess and maintain the proper license(s) and/or certification(s) may result in disqualification of proposal submittal or termination of the Contract after award. Copies of the respondent's license(s) and/or certification(s) which are applicable to this project shall be submitted as part of their bid submittal. Pursuant to section 607.1503(1), Florida Statutes, Corporations, out-of-state corporations are required to obtain a Florida Certificate of Authorization from the Florida Department of State, Division of Corporations, to transact business in the State of Florida.

2.7 Insurance Requirements

Contractor shall maintain, at their sole expense and during the term of this agreement insurance requirements set forth in the attached Exhibit C.

2.8 Bid Security/Bond

Bidders shall be required to submit a Bid Bond equal to five percent (5%) of the base bid.

Original Bid Bonds shall be submitted to and received by the City Clerk's Office in a sealed envelope referencing ITB 2024-09 no later than the submittal due date at:

City Clerk
City of Doral
8401 NW 53 Terrace
Doral, FL 33166

Awarded Bidder's failure to execute said Agreement and to furnish said Bonds and Insurance within ten (10) days from the date of such Notice will authorize the City to revoke the award and collect against the Bid Bond.

2.9 Payment Bond, and Performance Bond

Contractor shall be required to submit a Payment Bond and a Performance Bond in forms acceptable to the City of Doral, which shall be substantially as provided in the forms set forth within composite Exhibit D. Each such bond shall be in the amount of one hundred percent (100%) of the total contract price guaranteeing to the City the completion and performance of the Work covered in such Contract as well as full payment of all suppliers, material man, laborers, of Subcontractors employed pursuant to this Project. Each Bond shall be with a Surety company meeting the qualifications set forth herein.

Each Bond shall continue in effect for one and one half (1.5) years after final completion and acceptance of the Work with the liability equal to one hundred percent (100%) of the total contract price. The Performance Bond shall be conditioned that the Contractor will, upon notification by the City, correct any defective or faulty Work or materials which appear within one and a one half (1.5) years after final completion of the Contract.

Pursuant to the requirements of Section 255.05(1), Florida Statutes, the Contractor shall ensure that the Bond(s) referenced above shall be recorded in the public records of Dade County and Provide the City with evidence of such recording.

Each Bond required herein must be executed by a surety company authorized to do business in Florida as a surety, having a resident agent in the State of Florida and having been in business with a record of successful continuous operation for at least five (5) years.

The surety company shall hold a current certificate of authority as acceptable surety on federal bonds in accordance with the United States Department of Treasury Circular 570, current Revisions. Surety companies executing bonds must appear on the Treasury Department's most current list (circular 570 as amended) and be authorized to transact business in the State of Florida. The City will accept a surety bond from a company with a rating of A- or better.

Failure of the successful Bidder to execute and deliver the Agreement and deliver the required bonds and Insurance Certificates as stipulated herein shall be cause for the City to annul the Notice of Award and declare the Bid and any security therefore forfeited.

2.10 Hours of Work

Contractor will perform work Monday through Friday, excluding City holidays, from 8:00 a.m. to 6:00 p.m. unless prior written approval is received from The City. The Contractor must comply with the City's Noise Ordinance, Ordinance No. 2006-23.

2.11 On-Site Survey/As Built

Contractor shall be responsible for survey work required for establishing proper layout, elevations and grades as noted on the plans. The Contractor shall provide the City with three (3) sets of certified as-built plans and a CD containing PDF copy of the As-Built drawings as well as the CAD files, at no additional cost to the City.

2.12 Permits

Contractor shall obtain all permits necessary to conduct this project. The cost of all permits should be included on the bid proposal. If more than 1 Acre of land is disturbed during construction the Contractor is responsible to obtain NPDES Stormwater permit coverage through the Florida Department of Environmental Protection (FDEP) Construction Generic Permit (CGP). Instructions to request and obtain a CGP can be found at: <http://www.dep.state.fl.us/water/stormwater/npdes/docs/cgp.pdf>. Contractor should submit the Notice of Intent (NOI) with the appropriate processing fees to the NPDES Stormwater Notices Center. Contractor must apply for permit coverage at least two days before construction begins. In addition, the Contractor shall clear utilities prior to conducting any work at each project site. Contractor shall adhere to any restrictions imposed by FPL for conducting work under power lines.

2.13 Public Convenience and Safety

Contractor shall, at all times, conduct the Work in such a

manner as to ensure the least practicable obstruction to public travel. The convenience of the general public and of the residents and adjacent to the area of Work shall be provided for in a satisfactory manner, consistent with the operation and local conditions. Proper Maintenance of Traffic (MOT) devices shall be placed immediately adjacent to the Work, in a conspicuous position, at such locations as traffic demands. The MOT shall be designed as outlined in the latest edition of ROADWAY AND TRAFFIC DESIGN STANDARDS SERIES 600. At any time that streets are required to be closed or blocked, the Contractor shall notify law enforcement agencies before the street is closed and again as soon as it is opened. Access to fire hydrants and other fire extinguishing equipment shall be provided and maintained at all times.

The Contractor shall notify the Public Works Director whenever it is necessary to temporarily interrupt any business activities, the Contractor shall notify the City or tenant or their designee prior to the interruption and again immediately before the service is resumed. Before disconnecting any underground or overhead utilities, the Contractor shall make similar arrangements for their disconnection with the City, tenant or their designee. The Contractor shall be responsible for any damage caused by the Contractor to such utilities and shall restore them to service promptly as soon as the Work interruption has ended.

Contractor shall notify residents directly impacted by the project (including MOT), in writing, 72 hours prior to performing any work. Notification must include type of work to be performed; date work will begin and estimated completion date. In the event Contractor changes schedule or duration of work, Contractor must notify resident, in writing, of such changes. Contractor must provide a copy of all notifications to the City.

2.14 Safety and Protection

All work in fulfillment of this project shall be performed on City property or public right-of-way. No permission will be given to trespass on adjoining property. If property (public or private) is damaged during construction or is removed for the convenience of the work, it shall be repaired or replaced at the expense of the Contractor in a manner acceptable to the City of Doral prior to the final acceptance of the work. Such property shall include but not be limited to: pavement, sidewalks, curbs, driveways, walls, fences, footings, building façade, underground utilities, sod, shrubs, water sprinklers, signs, and trees.

The Contractor shall notify the Public Works Department in writing of the site having pre-existing damage to

sidewalks, curbs, facade, adjacent improvements, etc., before beginning work. Failure to do so shall obligate the Contractor to make repairs per above paragraph.

The Contractor shall be solely responsible for pedestrian and vehicular safety and control within the work site and shall provide the necessary warning devices, signage, barricades and ground personnel needed to give safety, protection, and warning to persons and vehicular traffic within the area. All safety devices must have suitable and sufficient lighting for the prevention of accidents.

The Contractor shall protect existing catch basins from sediment and debris with filter fabric while work is in progress. Filter fabric shall be removed after completion of work. Filter fabric must be cleaned periodically to avoid excessive accumulation of sediment and debris. Extreme care shall be taken when removing filter fabric to avoid sediments and debris from entering catch basin.

Contractor will be responsible for initiating, maintaining and supervising all safety precautions and programs in connection with the ROADWAY AND TRAFFIC DESIGN STANDARDS SERIES 600 TRAFFIC CONTROL THROUGH WORK ZONES latest edition. They will take all necessary precautions for the safety of, and will provide the necessary protection to prevent damage, injury or loss to: all employees and other persons whom may be affected thereby; all the Work and all materials or equipment to be incorporated therein, whether in storage on or off the work area; and all other property at the work area or adjacent thereto, including trees, shrubs, lawns, walks, pavements, roadways, structures and utilities not designated for removal, relocation or replacement in the course of construction.

The Contractor will designate an OSHA Certified "Competent Person", as defined under 29 CFR 1926.32(f), at the site whose duty shall be the prevention of accidents. Under the Excavation standards, tasks performed by the competent person include classifying soil, inspecting protective systems, designing structural ramps, monitoring water removal equipment, and conducting site inspections.

In addition, the competent person shall be available to receive verbal instructions from CEI Team or City representatives regarding installation, adherence to City standards, plans, and Contract Documents as a front-line representative of the Contractor.

Additional site tasks performed by the competent person include but are not limited to weekly safety briefings, daily adherence to MOT set up and takedown,

monitoring of resident and commercial stakeholder requests, and concurrence with CEI Team’s daily reports.

The City will not be responsible for the construction means, methods, techniques, sequences or procedures, or the safety precautions and programs incident thereto.

Should the City or the Contractor suffer injury or damage to its person or property because of any error, omission, or act of the other or of any of their employees or agents or others for whose acts they are legally liable, claim shall be made in writing to the other party within a reasonable time of the first observance of such injury or damage.

2.15 Trench Safety Act

Contractor shall comply with the State of Florida “Trench Safety Act” to the extent applicable, which was created to provide for increased worker safety by requiring compliance with sufficient standards for trench safety when the excavation is in excess of five (5) feet deep.

2.16 Emergencies

In emergencies affecting the safety of persons or the Work or property at the site or adjacent thereto, the Contractor, without special instruction or authorization from the City, is obligated to act, at their discretion, to prevent threatened damage, injury or loss. They will give the City prompt written notice of any significant changes in the Work or deviations from the Contract Documents caused thereby.

2.17 City’s Field Representative

The City will designate an individual to serve as the City’s Field Representative, which will be responsible to administer the Contract and communicate on behalf of the City. The Field Representative shall determine the amount and quality of several kinds of work performed and materials furnished which are to be paid for under the Contract.

The Field Representative will observe the Contractor’s work for compliance with the Contract Documents. Such observation will extend to any part of the work done and to the preparation, fabrication, or manufacture of the material to be used. Upon discovery of faulty workmanship or defective materials, the Field Representative shall call the Contractor’s attention to the same and reject work and materials not conforming to the requirements of the Contract Documents.

When any work in progress or completed is not Contract

Documents, the Field Representative order the Contractor to shut down that portion of the work affected until the affected work is corrected to the satisfaction of the Field Representative. The Field Representative shall confirm this later in writing as soon as practicable, detailing the reasons for the shutdown. Work performed in violation of the Field Representatives order to shut down will not be accepted or paid for.

The Field Representative is not authorized to revolt, alter, or waive any requirements of the contract. The Field Representative will negotiate and act on behalf of the Owner to the authorized limits of his authority as specified in the Contract Documents.

Whenever the Contractor intends to build, assemble or perform any portions of the work away from the site, the Contractor shall promptly notified the Field Representative of such intentions, including where and why no such work is to be performed, before such work starts. The Contractor shall also make arrangements for access thereto by the Field Representative so that the aforementioned portions of the work may be inspected as needed.

The fact that the Field Representative has not made early discovery of materials furnished or work performed does not meet the requirements of the Contract Documents, shall not bar the Field Representative from subsequently rejecting said materials or work and does not relieve the Contractor of his responsibility to meet the requirements of the Contract Documents.

The Field Representative shall not act as a foreman or perform other duties for the Contractor, nor interfere with the management of the work by the Contractor. The administration, observation of the work, and actions by the Field Representative, as herein provided, shall not be construed as undertaking supervisory control of the construction work or of means and the methods employed by the Contractor or his Subcontractors and shall not relieve the Contractor from any of his responsibilities or obligations under the contract; the Contractor shall not request or attempt to require the Field Representative to undertake such supervisor control or to administer, to supervise, to inspect, to assist, or to act in any manner so as to relieve the Contractor from such responsibilities or obligations.

The Field Representative shall decide all questions relating to the rights of different prime Contractors on the project or site. All materials and each part or detail of the

work shall be subject to observation by the Field Representative and/ or the Architect/ Engineer. The Architect/ Engineer and the Field Representative shall be allowed access to all parts of the work and shall be furnished with such information and assistance by the Contractor as is required.

2.18 Security

Work site(s) must be protected properly in accordance with all Federal, State, County and Municipal laws and ordinances, at the end of each workday and weekend. Contractor is responsible for project security. The Contractor shall protect and secure the site, materials, and equipment from theft and damage, by whatever means deems effective, at the Contractor's cost.

2.19 Work Site Conditions

The Contractor shall at all times ensure that the work site is maintained in a clean and orderly fashion. Contractor shall control dust by watering and sweeping at end of each workday or as directed by City. Dust control must meet City's satisfaction or City will control dust by whatever means deemed necessary and Contractor shall pay all expenses incurred by the City associated with dust control.

As soon as the work in any one locality is completed, the accumulated rubbish or surplus materials shall be promptly removed. The Contractor shall also restore all public and private property in a manner acceptable to the City, to a condition equal to or better than pre-construction conditions. This shall apply to public and private property which has been displaced or damaged during the prosecution of the work, and the Contractor shall leave the site and vicinity unobstructed and in a neat and presentable condition.

2.20 Existing Utilities, Structures, & Facilities

The underground pipes, utilities and structures shown on the Plans are located according to the best information available but may vary by several feet from both the position and elevation shown. The Contractor shall explore far enough ahead of his work to determine the exact location and condition of such utilities, structures or facilities so that, before the pipe is installed, the Engineer may change the line or grade of the pipe or other facility, should that become necessary to avoid a conflict. Should this exploration reveal that adjustments to the work are necessary; the Contractor shall immediately notify the Engineer and coordinate with him to adjust the work in a timely fashion avoiding delays to construction. No request for additional compensation or

Contract time (except for a non- compensable time extension at the sole discretion of the Engineer, whose decision shall be final) resulting from encountering utilities or structures not shown, or differing in location or elevation from that shown, will be considered. The Contractor shall explore sufficiently ahead of the Work to allow time for any necessary adjustments without delay to the progress of the installation. Costs due to delays occasioned by encountering underground utilities or structures which could have or should have been discovered by timely exploration ahead of the Work shall rest solely with the Contractor.

All cost for changing the grade of the proposed "new installation" downward two feet-six inches or less in order to clear obstructions located differently than shown on the Plans, or to clear obstructions located differently than shown on the Plans but the location of which could have become known or should have become known by proper observation of field conditions or the proper exploratory procedure, shall be included in the prices bid under the various items of the Proposal and no additional compensation will be allowed.

All pipes, sewers, drains and other pipe, cables, or conduits, and all other obstructions, whether or not shown, shall be temporarily removed from, or supported during excavation. It is intended that wherever piping systems or utilities such as water, wastewater, air, chemical, electrical or other service lines must be crossed, deflection of the pipe within recommended limits and cover shall be used to satisfactorily clear the obstruction unless otherwise indicated on the plans. The Contractor shall be held responsible for any damage to such installations and shall restore them to service immediately.

Changing the grade of the proposed main by rising deflections, or the alignment by horizontal deflections, will not be considered as extra work, or extra cost, to the Contractor, and in some cases a credit to the Department may be warranted.

Relocation of existing utilities: The relocation of existing utilities, as noted on the Plans, or for the convenience of the Contractor shall be the responsibility of the Contractor. This work shall be completed by either the forces of the existing utility or the Contractor's forces at the discretion of the responsible utility. If the work is to be performed by the Contractor, all work shall be done in accordance with the utility company's requirements. Under no circumstances shall the Contractor be

authorized extra payment for this work, and all cost for the relocation shall be the responsibility of the Contractor.

The Contractor shall also be responsible for the coordination of all existing utility relocations with the appropriate utilities. Where temporary supports or protective encasements are required during the construction, the Contractor shall be responsible for this work at no additional cost.

Any conflicts between the field investigation and the information shown on the plans shall be brought to the immediate attention of the City.

2.21 Changes to the Work

The City may, at any time or from time to time, without notice to the sureties, and only in writing, order additions, deletions or revisions in the Work; these shall be authorized by Change Orders. A Change Order may include any change in the Work within the general scope of the Contract, including but not limited to changes in the specifications (including drawings and designs); in the method or manner of performance of the Work; in the City-furnished facilities, equipment, materials, services, or site; or in directing acceleration in the performance of the Work.

Upon receipt of a Change Order, the Contractor will proceed with the Work involved. All such Work shall be executed under the applicable conditions of the Contract Documents. All Change Orders that add or delete work, or increase or decrease Time, may result in an adjustment to the Contract Price and Time accordingly. Any such changes must be reflected in the Change Order(s), which when signed by the Contractor, shall indicate an agreement of the parties therewith.

The City may authorize minor changes or alterations in the Work not involving extra cost and not inconsistent with the overall intent of the Contract Documents. These may be accomplished by a Field Order. Additional Work performed by the Contractor without authorization of a Change Order will not entitle the Contractor to an increase in the Contract Price or an extension of the Contract Time, except in the case of an emergency as provided in this Solicitation. The City will execute appropriate Change Orders prepared by the City covering changes in the Work to be performed and Work performed in an emergency and any other claim of the Contractor for a change in the Contract Time or the Contract Price which is approved by the City.

It is the Contractor's responsibility to notify his Surety of any changes affecting the general scope of the Work or change in the Contract Price or Contract Time and the amount of the applicable bonds shall be adjusted accordingly. The Contractor will furnish proof of such an adjustment to the City.

2.22 Changes to the Contract Time or Price

The Contract Price constitutes the total compensation payable to the Contractor for performing the Work. All duties, responsibilities and obligations assigned to or undertaken by the Contractor shall be at their expense without changing the Contract Price. Except as herein provided, no order, statement, or conduct of the City shall be treated as a change under this clause or entitle the Contractor to an adjustment to the Contract Price or Time.

If any change order under this clause causes an increase or decrease in the Contractor's cost of, or the time required for, the performance of any part of the Work, under this Contract, whether or not changed by any order, the Contract Price and Time will be adjusted in writing by the same amount.

If the Contractor intends to assert a claim for an adjustment in Contract Price or Time under this clause, he must, within ten (10) days after receipt of a written Change Order, submit to the City a written notice including a statement setting forth the general nature and monetary extent of such claim, and supporting data. No claim by the Contractor for an adjustment in Contract Price or Time hereunder shall be allowed if not submitted in accordance with this section or if asserted after final payment under this Contract.

The value of any Work covered by a Change Order or of any claim for an increase or decrease in the Contract Price shall be determined either by negotiated lump sum or on the basis of the cost of the Work, determined as provided below, plus a mutually agreed upon fee to the Contractor to cover overhead and profit.

The term cost of the Work means the sum of all direct costs necessarily incurred and paid by the Contractor in the proper performance of the Work. Except as otherwise may be agreed to in writing by City, such costs shall be in amounts no higher than those prevailing in Miami-Dade County, shall include only the following items:

- Payroll costs for employees in the direct employ of

Contractor in the performance of the Work described in the Change Order under schedules of job classifications agreed upon by City and Contractor. Payroll costs for employees not employed full time on the Work shall be apportioned based on their time spent on the Work. Payroll costs shall be limited to salaries and wages, plus the costs of fringe benefits which shall include social security contributions, unemployment, excise and payroll taxes, workers' compensation, health and retirement benefits, sick leave, vacation and holiday pay applicable thereto. Such employees shall include superintendents and foremen at the site. The expenses of performing Work after regular working hours, on Sunday or legal holidays shall be included in the above only if authorized by City.

- Cost of all materials and equipment furnished and incorporated in the Work, including costs of transportation and storage, and manufacturers' field services required in connection therewith. All cash discounts shall accrue to Contractor unless City deposits funds with Contractor with which to make payments in which case the cash discounts, shall accrue to the City. All trade discounts, rebates and refunds, and all returns from sale of surplus materials and equipment shall accrue to City, and Contractor shall make provisions so that they may be obtained.
- Payments made by Contractor to the Subcontractors for Work performed by Subcontractors. If required by City, Contractor shall obtain competitive bids from Subcontractors acceptable to him and shall deliver such bids to CITY who will then determine which Bids will be accepted. If a Subcontract provides that the Subcontractor is to be paid on the basis of Cost of Work plus a fee, the cost of the Work shall be determined in accordance with this section.
- Rentals of all construction equipment and machinery and the parts thereof whether rented from Contractor or others in accordance with rental agreements approved by City with the advice of Contractor, and the costs of transportation, loading, unloading, installation, dismantling and removal thereof - all in accordance with terms of said rental agreements. The rental of any equipment or machinery shall cease when the use thereof is no longer necessary for the Work.
- Sales, use or similar taxes related to the Work, and for which Contractor is liable, imposed by any governmental authority.
- Payments and fees for permits and licenses. Costs for permits and licenses must be shown as a

separate item.

- Utilities, fuel and sanitary facilities at the site.
- Minor expenses such as telegrams, long distance telephone calls, telephone service at the site, expressage and similar petty cash items in connection with the Work.
- Cost of premiums for additional Bonds and Insurance required solely because of changes in the Work, not to exceed two percent (2%) of the increase in the Cost of the Work.

The term cost of the Work shall not include the following:

- Payroll costs and other compensation of Contractor's officers, executives, principals (of partnership and sole proprietorships), general managers, engineers, architects, estimators, lawyers, agents, expeditors, timekeepers, clerks and other personnel employed by Contractor whether at the site or in his principal or a branch office for general administration of the Work and not specifically included in the schedule of Work all of which are to be considered administrative costs covered by the Contractor's fee.
- Expenses of Contractor's principal and branch offices other than his office at the site.
- Any part of Contractor's capital expenses, including interest on Contractor's capital employed for the Work and charges against Contractor for delinquent payments.
- Cost of premiums for all bonds and for all insurance policies whether Contractor is required by the Contract Documents to purchase and maintain the same (except as otherwise provided above).
- Costs due to the negligence of the Contractor, any Subcontractor, or anyone directly or indirectly employed by any of them for whose acts any of them may be liable, including but not limited to, correction of defective work, disposal of materials or equipment wrongly supplied and making good any damage to property.
- Other overhead or general expense costs of any kind not otherwise expressly included as an appropriate cost of Work under this Solicitation.

Upon the issuance of a Change Order, Contractor's overhead and profit shall be determined as follows:

- In the event of an oversight or omission by the Contractor no compensation for overhead or profit will be provided.
- If the Change Order is not due to the Contractor's oversight or omission, overhead and profit shall be

a mutually acceptable firm fixed price.

- If no fixed price can be agreed upon, then ten percent (10%) fixed fee based on the estimate of the various portions of the Cost of the Work.

Whenever cost of Work is to be determined pursuant to the above process, the Contractor will submit in form prescribed by City an itemized cost breakdown together with supporting data.

The amount of credit allocated by the Contractor to the City for any change order which results in a net decrease in cost will be the amount of the actual net decrease. When both additions and credits are involved in any one change, the net shall be computed to include overhead and profit, identified separately, for both additions and credit, provided however, the Contractor shall not be entitled to claim lost profits for any Work not performed.

Force Account Work

If the City and the Contractor cannot reach an agreement on an equitable adjustment to the Contract Price for any work as prescribed above, then the additional Work will be performed on a Force Account basis as directed by the City’s Field Representative with review by the Architect/ Engineer and paid for as specified below.

In the event additional Work is performed on a Force Account basis, then the Contractor and the Subcontractors, as appropriate, shall maintain itemized daily records of cost, quantities, labor and the use of authorized special equipment or machinery.

The itemized daily record will be submitted to the Architect/Engineer daily for approval, which shall be subject to audit by the City. The Contractor, including its Subcontractor(s) of any tier performing the work, and the Architect/ Engineering shall compare records of the cost of force account work at the end of each day. The agreement shall be indicated by signature of the Contractor, the Subcontract performing the work, and the Architect/ Engineer or their duly authorized representatives.

No payment will be made for work performed on a force account basis until the Contractor has furnished the Architect/ Engineer with duplicate itemized statements of the cost of such force account work detailed as follows:

- Name, classification, dates, daily hours, total hours, rate and extension for each laborer, tradesman, and foreman.
- Designation, dates, daily hours, total hours, rental

rate, and extension of each unit of special machinery and equipment.

- Quantities of materials, prices, and extensions.
- Transportation of materials.

The statements shall be accompanied and supported by a receipted invoice of all materials used and transportation charges. However, if materials used on the force account work are not specifically purchased for such work but are taken from the Contractor’s stock, then in lieu of the invoices the Contractor shall furnish an affidavit certifying that such materials were taken from its stock, that the quantity claimed was actually used, and that the price and transportation claimed represent the actual cost to the Contractor.

2.23 Value Engineering Change Proposals

The Contractor may submit to the City’s Architect/Engineer one or more cost reduction proposals for changing the Contract requirements. The proposals shall be based upon a sound study made by the Contractor indicating that the proposal:

- Will result in a net reduction in the total cost;
- Will not impair any essential function or characteristic of the Work such as safety, service life, reliability, economy of operation, ease of maintenance and necessary standardized features;
- Will not require an unacceptable extension of the Contract completion time; and
- Will require a change in the Contract Documents and such change is not already under consideration by the Owner.

Contractor shall specifically identify any such proposals under this section with the heading “Value Engineering Change Proposal”. The Owner may accept in whole or in part any proposal submitted pursuant to the previous paragraph on Value Engineering Change Proposals by issuing a Change Order which will identify the proposal on which it is based. The Change Order will provide for a Contract change in the Contract price and will revise any other affected provisions of the Contract Documents. The equitable adjustment in the Contract price will be established by determining the net savings resulting from the accepted change. The net savings resulting from the change will be shared between the Contractor and the Owner based on 50 percent for the Contractor and 50 percent for the Owner and will be limited to 10 percent of the total construction contract amount for all Value Engineering Change Proposal submitted via Change Order. Net savings will be determined by deducting from the proposal’s estimated gross savings (1) the

Contractor's costs of developing and implementing the proposal (including any amount attributable to a subcontractor) and (2) the estimated amount of increased costs to the Owner resulting from the change, such as evaluation, implementation, inspection, related items, and Owner - furnished material. Estimated gross savings will include Contractor's labor, material, equipment, overhead, profit and bond. The Contract price will be reduced by the sum of the Owner's costs and share of the net savings. For the purposes of this article, the applicable provisions of the Contract Documents shall be used to determine the equitable adjustment to the Contract price.

The Owner will not be liable for delay in acting upon, or for failure to act upon, any proposals submitted pursuant to of this article. The decision of the Owner as to the acceptance or rejection of any such proposal under the Contract will be final. The submission of a proposal by the Contractor will not in itself reflect the rights or obligation of either party under the Contract.

The Contractor shall have the right to withdraw part or all of any Value Engineering Change Proposal he may make at any time prior to acceptance by the Owner. Such withdrawal shall be made in writing for the Architect/ Engineer. Each such proposal shall remain valid for a period of 60 days from the date submitted. If the Contractor wishes to withdraw the proposal prior to the expiration of the 60-day period he will be liable for the cost incurred by the City in reviewing the proposal.

2.24 Suspension of Work and Termination

The City may, at any time and without cause, suspend the Work or any portion thereof for a period of not more than ninety (90) days by notice in writing to the Contractor which shall fix the date on which Work shall be resumed. For suspensions longer than ninety (90) days, The Contractor will be allowed an increase in the Contract Price or an extension of the Contract Time, or both, directly attributable to any suspension if they make a claim in accordance with the process set forth in this Solicitation.

Work shall be suspended during inclement weather when the weather is unfit for good and careful Work to be performed unless written permission is provided by the City. Should the severity of the weather continue, the Contractor upon the direction of the City, shall suspend all Work until instructed to resume operations by the City and the Contract Time shall be extended to cover the duration of the order.

If the Contractor is adjudged bankrupt or insolvent, or if they make a general assignment for the benefit of their creditors, or if a trustee or receiver is appointed for the Contractor or for any of their property, or if they file a petition to take advantage of any debtor's act, or to reorganize under bankruptcy or similar laws, or if they repeatedly fails to supply sufficient skilled workmen or suitable materials or equipment, or if they repeatedly fail to make prompt payments to Subcontractors or for labor, materials or equipment or they disregards laws, ordinances, rules, regulations or orders of any public body having jurisdiction, or if they disregard the authority of the City, or if they otherwise violate any provision of the Contract Documents, then the City may, without prejudice to any other right or remedy and after giving the Contractor and their surety seven (7) days written notice, terminate the services of the Contractor and take possession of the Project and of all materials, equipment, tools, construction equipment and machinery thereon owned by the Contractor, and finish the Work by whatever method they may deem expedient. In such case the Contractor shall not be entitled to receive any further payment until the Work is finished. If the unpaid balance of the Contract Price exceeds the direct and indirect costs of completing the Project, including compensation for additional professional services, such excess shall be paid to the Contractor. If such costs exceed such unpaid balance, the Contractor will pay the difference to the City. Such costs incurred by the City will be determined by the City and incorporated in a Change Order.

Without limitation of the foregoing, upon seven (7) days written notice to the Contractor, the City may, without cause and without prejudice to any other right or remedy, elect to terminate the Agreement. In such case, the Contractor shall be paid for all Work executed and accepted by the City as of the date of the termination. No payment shall be made for profit for Work which has not been performed.

If after termination of the Contractor under this Section, it is determined by a court of competent jurisdiction for any reason that the Contractor was not in default, the rights and obligations of the City and the Contractor shall be the same as if the termination had been issued pursuant to the City's right to terminate for convenience as set forth in this Solicitation.

Where the Contractor's services have been so terminated by the City said termination shall not affect any rights of the CITY against the Contractor then existing or which may thereafter accrue. Any retention or

payment by the City due to Contractor will not release the Contractor from liability.

In the case of termination of this Contract before completion for any cause whatever, the Contractor, if notified to do so by the City, shall promptly remove any part or all of his equipment and supplies from the property of the City. Should the Contractor not remove such equipment and supplies, the City shall have the right to remove them at the expense of the Contractor. Equipment and supplies shall not be construed to include such items for which the Contractor has been paid in whole or in part.

If, through no act or fault of the Contractor, the Work is suspended for a period of more than ninety (90) days by the City or under an order of court of other public authority, or the Contractor fails to act on any Application for Payment within thirty (30) days after it is submitted, or the City fails to pay the Contractor any sum approved by the City, within thirty (30) calendar days of its approval, and presentation, then the Contractor may, upon twenty (20) calendar days written notice to the City, terminate the Agreement. The City may remedy the delay or neglect within the twenty (20) calendar days' time frame. If timely remedied by the City the Contract shall not be considered terminated. In lieu of terminating the Agreement, if the City has failed to act on an Application for Payment or the City has failed to make any payment as aforesaid, the Contractor may upon ten (10) calendar days' notice to the City and the Contractor stop the Work until they have been paid all amounts then due. If the Contractor stops neither by default nor by non-payment from the City, the Contractor will be responsible for 100% of the difference between the total of his/her Bid and the second lowest Bid.

2.25 Payments and Completion

At least ten (10) days before each progress payment falls due (but not more often than once a month), the Contractor will submit to the City a partial payment estimate filled out and signed by the Contractor covering the Work performed during the period covered by the partial payment estimate and supported by such data as the City may reasonably require.

The City will within ten (10) days after receipt of each partial payment estimate, either indicate in writing their approval of payment and present the partial payment estimate to the City, or return the partial payment estimate to the Contractor, indicating in writing their reasons for refusing to approve payment. In the latter case, the Contractor may make the necessary

corrections and resubmit the partial payment estimate. The City, will within thirty (30) days of presentation to them of any approved partial payment estimate, pay the Contractor a progress payment on the basis of the approved partial payment estimate. The City may retain five percent (5%) of the amount of each payment until final completion and acceptance of all Work covered by the Contract Documents. On completion and acceptance of a part of the Work on which the price is stated separately in the Contract Documents, payment may be made in full, including retained percentages, less authorized deductions. Any interest earned on the retainage shall accrue to the benefit of the City.

The City will provide Contractor with the appropriate forms by which to submit the progress payment estimates and requests as well as the certification of Contractor; partial release by subcontractors, suppliers, and/or Contractor; and any additional documents the City may reasonably require.

The City shall have the right to receive from the Contractor, before Contractor receives final payment, final releases of lien executed by all persons, firms or corporations who have performed or furnished labor, services or materials, directly or indirectly, used in the Work; inclusive of Final As-builts. Likewise, as a condition to receiving any progress payment, the City may require the Contractor to furnish partial releases of lien executed by all persons, firms and corporations who have furnished labor, services or materials incorporated into the Work during the period of time for which the progress payment is due, releasing such lien rights as those persons, firms or corporations may have for that period, red-line as-builts, progress schedule.

Acceptance by Contractor of final payment shall operate as a release to the City and a waiver of all claims and all liability to the Contractor other than claims in stated amounts as may be specifically excepted by the Contractor for all things done or furnished in connection with the Work and for every act and neglect of the City and others relating to or arising out of this Work. Any payment, however, final or otherwise, shall not release the Contractor of their sureties from any obligations under the Contract Documents or the Performance Bond and Payment Bonds.

2.26 Testing & Inspections

The Field Representative, Architect or Engineer and other representatives of City, testing agencies and governmental agencies with jurisdictional interests shall have access to the Work at reasonable times for their

observation, inspecting and testing. Contractor shall provide proper and safe conditions for such access.

The Contractor shall give City timely notice of readiness of the Work for all required inspections, tests, observations or approvals. Inspections, tests or observations by the City's Representative, the Architect or Engineer, City or its agents may be performed at its discretion to provide information to the City on the progress of the Construction. However, such information is not intended to fulfill the Contractor's obligations in accordance with the Contract Documents.

Contractor shall assume full responsibility, pay all costs in connection therewith and furnish City the required certificates of inspection, testing or approval for all materials, equipment or the Work or any part thereof unless otherwise specified herein.

Storm Sewer System Testing

- Equipment must conform to applicable sections of ASTM and all other applicable industry standards and codes.
- Clean all manholes, pipes, and structures by removing sheeting, bracing, forms, soil sediment, concrete waste, and other debris.
- Do not discharge soil sediment or debris to drainage channels or existing storm sewers. Dispose of properly in a waste containment site that is acceptable to the City.
- Examine structures and pipes for:
 - Damage.
 - Indication of displacement of reinforcement, forms, pipes, or bedding.
 - Porous areas or voids.
 - Proper placement of seals, gaskets, and embedment.
 - Visible infiltration.
- Verify that structures and pipes are set to true line, grade, and plumb.
- Verify structure and pipe dimensions and thickness.
- Measure actual inside dimensions of all flexible pipe prior to installation. Use these dimensions when sizing the mandrel should deflection testing be required.
- Storm sewer pipes shall be inspected by flashing a light between structures or by physical passage where space permits.
 - Lamping shall be done after pipe trench backfill is compacted and brought to grade or pavement subgrade.
 - Full pipe diameter ("full moon") shall be visible for grade alignment.

- No less than half pipe diameter ("half-moon") shall be visible for horizontal alignment.
- Storm sewer structures shall be plugged in each direction and cleaned thoroughly to the bottom of sump area.
 - There will be no sediment or debris permitted and all pipe inlets connections will be watertight.
 - The tops of structures will be thoroughly sealed inside and out with no brick exposure.
 - Manhole rim and covers will be thoroughly sealed inside and out with no brick exposure.

Density Testing

Density tests shall be taken by an independent testing laboratory certified by the State of Florida and approved by the designated City representative and shall be paid for by Contractor, at no additional cost to the City. A compaction test, for both the base and subgrade, shall be performed for every section of new pavement and at least one (1) test for every 250 square yards of new pavement. In addition, density testing shall be performed for installation in swale areas at a frequency of one test per 50 feet of trench, or adjacent to newly installed inlets at the discretion of the City representative.

Compaction test reports of sub-grade and base rock shall be submitted for approval to the designated City representative prior to installation of final asphaltic wearing surface.

If any Construction that is to be inspected, tested or approved is covered without written concurrence of City's Representative, it must, if requested by City or the City's Representative, be uncovered for observation. Such uncovering shall be at Contractor's expense and will exclude the right to an increase in the Contract Price or Contract Time unless Contractor has given City or the City's Representative timely written notice of Contractor's intention to cover such Construction and City, or the City's Representative has not acted with reasonable promptness in response to such notice.

If City considers it necessary or advisable that covered Work be observed by City's Representative or the Architect or Engineer, or inspected or tested by others, Contractor, at City's request, shall uncover, expose or otherwise make available for observation, inspection or testing as City may require, that portion of the Work in question, furnishing all necessary labor, material and equipment. If it is found that such Work is defective, Contractor shall bear all the expenses of such uncovering, exposure, observation, inspection and

testing and of satisfactory reconstruction, including compensation for additional professional services and any additional expenses experienced by the City due to delays to others performing additional work, other contractual obligations, and City shall be entitled to issue an appropriate deductive Change Order. Contractor shall further bear the responsibility for maintaining the schedule and will not be allowed an increase in Contract Price or Contract Time due to the uncovering. If, however, such Construction is not found to be defective, Contractor shall be allowed an increase in the Contract Price or the Contract Time, or both, directly attributable to such uncovering, exposure, observation, inspection, testing and reconstruction if it makes a claim therefore as provided in accordance with the Contract Documents.

Except as otherwise provided, sampling and testing of all materials, and the laboratory methods and testing equipment required under these specifications shall be in accordance with the latest standards of the American Society for Testing Materials.

The Contractor shall furnish the required samples for testing without charge. The Contractor shall provide at least 24-hour notice when requesting testing to be performed. In locations where coring's are taken by the approved testing lab, the Contractor shall be responsible for plugging these core holes.

All material tests will be made by an independent testing laboratory that may be selected by the City. Excluding Density Testing, where tests indicate that materials are in accordance with specified requirements, the City shall bear the testing cost. When tests reveal that conditions or materials do not comply with the specifications, the cost of such tests shall be assessed against the Contractor.

2.27 Contractor's General Warranty & Guarantee

Contractor warrants and guarantees to City that all Work shall be in accordance with the Contract Documents and will not be defective. Contractor further warrants and guarantees that title to all Work, materials and equipment covered by an application for payment, whether incorporated in the Project or not, will have passed to the City prior to the making of the application for payment, free and clear of all liens, claims, security interest and encumbrances (hereafter referred to as "Liens"); and that no Work, materials or equipment covered by an application for payment will have been acquired by the Contractor or by any other person performing the Work at the site or furnishing materials and equipment for the project, subject to an agreement under which an interest

therein or encumbrance thereon is retained by the seller or otherwise imposed by the Contractor or such other person.

The Contractor's obligation to perform and complete the Work in accordance with the Contract Documents shall be absolute. None of the following will constitute an acceptance of Work that is not in accordance with the Contract Documents or a release of Contractor's obligation to perform the Work in accordance with the Contract Documents:

- Observations by City or City's Representative, based on the recommendation of the Architect or Engineer;
- Payment by City of any progress or final payment;
- The issuance of a certificate of Substantial Completion, certificate of Final Completion, or any payment related thereto by City;
- City's use or occupancy of the Work;
- Any acceptance by City or any failure to do so;
- Any review and approval of a submittal or the issuance of a notice of acceptability by the City's Representative;
- Any inspection, test, or approval by others; or
- Any correction of defective Work by City.

If the Contractor is notified to correct defective or nonconforming work, and the Contractor fails to promptly proceed with corrective action in a reasonable time, the City may, at its sole discretion and upon written notice to Contractor, complete the redesign, repair, rework or replacement of nonconforming work by the most expeditious means available and back charge the Contractor for the cost incurred. The cost of back charge work shall include all reasonable costs associated with the corrective action. The City shall separately invoice or deduct from payments, otherwise due to the Contractor, the costs as provided herein. The City's right to back charge is in addition to any for all other rights and remedies provided in this contract, or by law. The performance of work, on behalf of the City, shall not relieve the Contractor of any of its responsibilities under this contract including but not limited to express or implied warranties, specified standards of quality, contractual liabilities and indemnification, and the Contract Time.

The City will have authority to disapprove or reject Work which is "defective" (which term is hereinafter used to describe Work that is unsatisfactory, faulty or defective, or does not conform to the requirements of the Contract Documents or does not meet the requirements of any

inspection, test or approval referred to in Special Condition, or has been damaged prior to final acceptance) at Contractor's expense.

If the Work is defective, or Contractor fails to supply sufficient skilled workers or suitable materials or equipment, or fails to furnish or perform the Work in such a way that the completed Work will conform to the Contract Documents, City may order Contractor to stop the Work, or any portion thereof, until the cause for such failure has been eliminated; however, this right of City to stop the Work shall not give rise to any duty on the part of City to exercise this right for the benefit of Contractor or any other party. The Contractor shall not be allowed an increase in Contract Price or the Contract Time or both as a result of the stopping of Work under this section.

If required by the City's Representative, with the recommendation of the Architect and/or Engineer, Contractor shall promptly, as directed, either correct all defective Work, whether or not fabricated, installed or completed, or, if the Work has been rejected by the City's Representative, upon the recommendation of the Architect or Engineer, remove it from the site and replace it with non-defective Work. Contractor shall bear all direct, indirect and consequential costs of such correction or removal (including but not limited to fees and charges of the City's Representative, the Architect or Engineer, attorneys and other professionals) made necessary thereby.

Without prejudice to any other right of the City, if within one (1) year after the date of final completion or within any designated manufacturer's warranty, whichever is greater, or such longer period of time as may be prescribed by laws or regulations or by the terms of any applicable special guarantee required by the Contract Documents or by any specific provision of the Contract Documents, any Work is found to be defective, Contractor shall promptly, without cost to City and in accordance with City's written instructions, either correct such defective Work, or, if it has been rejected by City or the City's Representative, based on the recommendation of the Architect or Engineer, remove it from the site and replace it with non-defective Work. If Contractor does not promptly comply with the terms of such instructions, or in an emergency where delay would cause serious risk of loss or damage, City may have the defective Work corrected or the rejected Work removed and replaced, and all of the City's direct, indirect and consequential costs of such removal and replacement (including but not limited to fees and charges of the

Architect or Engineer) will be reimbursed by Contractor. In special circumstances where a particular item of equipment is placed in continuous service before Substantial Completion of all the Work, the correction period for that item may start to run from an earlier date if so, provided in the Specifications or by written amendment.

City shall reserve and retain all of its rights and remedies at law and equity against Contractor and its surety for damages and for corrections of any and all latent defects.

Any defective Construction that is either corrected or rejected and replaced will be warranted and guaranteed for a period of one (1) year from the date of acceptance of such correction or removal and replacement, even if it had previously been corrected or replaced, in accordance with the provisions of this Article 12. If within such an extended Warranty Period, the Work is once again found to be defective, City shall be entitled to all of City's rights and remedies under this Article.

2.28 Materials

The Contractor warrants that all materials and equipment shall be of good quality and new, unless otherwise provided in the specifications and that the work will be free from defects whether patent or latent in nature. All materials and equipment shall be applied, installed, connected, erected, used, cleaned and conditioned in accordance with the instructions of the applicable supplier except as otherwise provided in the specifications.

The Contractor shall store materials, at his expense, in areas approved by the City. The Contractor, at their own expense, shall maintain these areas in a clean, orderly condition so as not to cause a nuisance in the area. The Contractor shall restore the storage area to its original or better condition, with all its appurtenances, in kind, to the satisfaction of the City, at the Contractor's discretion, if the Contractor chooses to stage material outside of the designated area, with prior approval from the City.

All salvageable material and/or equipment removed from the existing construction for which specific use, relocation or other disposal is not specifically noted on the drawings or otherwise specified, will remain the property of the City and be turned over to the City. All material and/or equipment not in salvageable condition as determined by the City Representative must be disposed of by the Contractor. The actual storage site for salvageable material will be designated by the City.

All excess excavated material and debris not required for backfill (unless otherwise noted), including broken pipe, sidewalks, curbs and other concrete items, together with all roots, boards and other debris are to be disposed of by the Contractor at an appropriate legal site, at no additional cost to the City.

2.29 Equipment

All construction equipment necessary and required for construction of this project shall be on the construction site, in excellent working condition, before construction is permitted to start. The Contractor shall provide such tamping tools and equipment as are necessary for the proper compaction of the backfill material.

2.30 Water Usage

All City potable water used during the project shall be metered through a hydrant meter or meters obtained from the Miami-Dade County Water and Sewer Department at the Contractor's expense.

2.31 Staging

No staging site is available for this project. Contractor must use available space along the public right-of-way without impacting or closing sidewalks and/or the roadway or provide documentation for Contractor selected staging area prior to commencement of work. The staging site/area is the responsibility of the Contractor and the Contractor shall be responsible for the restoration of the area at no additional cost to the City. Staging sites shall be protected and shall have erosion and sedimentation control measure such as silt fence, at no additional cost to the City.

2.32 Liquidated Damages

Upon failure of the Contractor to complete the Work within the time specified for completion, (plus approved extensions if any) the Contractor shall pay to the City the sum of ONE THOUSAND SIX HUNDRED AND SIXTY-FIVE DOLLARS AND 00/100 (\$1,665.00) for each calendar day that the completion of the Work is delayed beyond the time specified in the Contract for completion, as fixed and agreed liquidated damages and not as a penalty. Liquidated damages are hereby fixed and agreed upon between the parties, recognizing the impossibility of precisely ascertaining the amount of damages that will be sustained by the City as a consequence of such delay and both parties desiring to obviate any question of dispute concerning the amount of said damages and the cost and effect of the failure of the Contractor to complete the Contract on time. Regardless of whether or not a single Contract is

involved, the above-stated liquidated damages shall apply separately to each portion of the Work for which a time of completion is given. The CITY shall have the right to deduct from and retain out monies which may be then due, or which may become due and payable to the Contractor, the amount of such liquidated damages, the Contractor shall pay in full such liquidated damages.

[END OF SECTION]

ARTICLE 3 – SCOPE OF WORK / TECHNICAL SPECIFICATIONS

3.1 Purpose and Intent

The City of Doral is seeking sealed bids from qualified Contractors for all material, labor, equipment and services to accomplish the Section 7 Traffic Calming work, as more particularly described in this ITB.

3.2 Scope of Work

The Section 7 Traffic Calming work generally entails the installation of speed tables, raised crosswalk, raised intersection, and new speed limit signs in multiple locations, which will require grading, demolition, installations, curb and gutter, asphalt paving and milling, striping, signage, landscaping, and implementation of all related materials as shown on the Roadway Plan dated July 28, 2023 and the Signing and Pavement Marking Plans dated September 18, 2023 and prepared by H.W. Lochner, Inc., both of which are attached hereto as composite Exhibit E.

The City reserves the right to utilize any combination of the base bid, add alternates as they so desire to achieve the proper balance between the required improvements, desired improvements, and the City's available project budget. The City reserves the right to request per unit/each pricing of materials listed on the bid form for clarification or to purchase additional materials.

3.3 Qualifications

For Contractors to be considered, Contractors must submit with their bid evidence that they have sufficient experience and are qualified to satisfactorily perform the work required by this Solicitation, in the City's sole discretion.

Accordingly, Contractors must provide evidence of the successful completion of at least three roadway improvement projects of at least half a million dollars (\$500,000) each in construction costs performed in Miami-Dade County or Broward County within the last three years. Each project listed must have been performed for local government, County and/or state agency and also include verifiable references.

Additionally, one of the following licenses is required within the bid submittal package: State of Florida Certified Electrical Contractor, State of Florida Certified Underground Utility and Excavation Contractor, or a State Registered Electrical Contractor with license in Miami Dade County as issued by the Construction Trades Qualifying Board (CTQB).

3.4 Additional Specifications

In addition to the requirements set forth in the body of this solicitation, Awarded Contractor shall comply with the provisions and specifications contained in the following documents, which are attached and incorporated herein as composite Exhibit D:

1. Preconstruction Conference
2. Site Conditions
3. Hurricane Preparedness
4. Protection of Existing Facilities, Vegetation, Structures, Utilities, and Improvements
5. Interference with Existing Utilities
6. Environmental Protection and Special Controls
7. Contaminated Soil / Groundwater
8. Clearing and Grubbing / Landscaping / Site Cleanliness
9. Concrete Driveway, Sidewalk, and Curb and Gutter Removal and Replacement

10. Excavation / Trench Stabilization / Trench Overcut / Compacted Backfill
11. Shop Drawings, Product Data, and Samples
12. Form of Bid Bond
13. Form of Payment Bond
14. Form of Performance Bond

[END OF SECTION]

ARTICLE 4 – REQUIRED SUBMISSION FORMS

INTERESTED PROPOSERS SHALL SUBMIT THE FOLLOWING FORMS IN THE EXACT SEQUENCE PROVIDED, INCLUDING INSERTION OF DOCUMENTS WHERE SPECIFIED. THE FOLLOWING MATERIALS ARE CONSIDERED ESSENTIAL AND NON-WAIVABLE FOR ANY RESPONSE TO THIS SOLICITATION.

The required submission forms are attached to this Solicitation as Exhibit A, and are inclusive of the following:

1. Solicitation Response Form
2. Bid Price Sheet
3. Bidder Qualification Statement
4. List of Proposed Subcontractors
5. Bidder/Proposer Affidavits
 - Ownership Disclosure
 - Public Entity Crimes
 - Compliance with Foreign Entity Laws
 - Disability Non-Discrimination & Equal Employment Opportunity
 - Conformance with OSHA Standards
 - E-Verify Program Affidavit
 - No Contingency Affidavit
 - Copeland “Anti-Kickback” Act Affidavit
 - Non-Collusion Affidavit
 - Drug Free Workplace Program
 - Cone of Silence Certification
 - Bidder Certification
6. Conflict of Interest Disclosure
7. Certificate of Authority
8. Trench Safety Form

SOLICITATION RESPONSE FORM

**City of Doral ITB No. 2024-09
Construction of Section 7 Traffic Calming Improvements**

Date Submitted	
Company Name	
Date of Entity Formation	
Entity Type (select one)	Corporation / Partnership / LLC / Other:
Corporate Address	
Office Location	
FEI/EIN No.	
Authorized Representative (Name and Title)	

- Bidder has the following License (select at least one and attach copy):
 - State of Florida Certified Electrical Contractor
 - State of Florida Certified Underground Utility and Excavation Contractor
 - State Registered Electrical Contractor
- The undersigned Bidder/Proposer agrees, if this Bid is accepted by the City, to enter into an agreement with the City of Doral to perform and furnish all goods and/or services as specified or indicated in the Contract for the Price and within the timeframe indicated in this proposal and in accordance with the terms and conditions of the Contract.
- Bidder/Proposer accepts all of the terms and conditions of the Solicitation, including without limitation those dealing with the disposition of Bid Security. This Bid will remain subject to acceptance for 180 days after the day of Bid opening. Bidder/Proposer agrees to sign and submit the Contract with any applicable documents required by this ITB within ten days after the date of City’s Notice of Award (If applicable).
- By responding to this sealed Solicitation, the Bidder/Proposer makes all representations required by the Solicitation and further warrants and represents that Bidder/Proposer acknowledges that it has received and examined copies of the entire Solicitation documents including all of the following addenda:

Addendum No.: _____ Dated: _____ Addendum No.: _____ Dated: _____

Addendum No.: _____ Dated: _____ Addendum No.: _____ Dated: _____

Check here If no Addenda were issued.
- Bidder/Proposer further warrants and represents that it has familiarized themselves with the nature and extent of the Contract, required goods and/or services, site, locality, and all local conditions and applicable laws and regulations that in any manner may affect cost, progress, performance, or furnishing of the Work.
- Bidder/Proposer further warrants and represents that it has studied carefully all reports and drawings of subsurface conditions and drawings of physical conditions to the extent applicable to the Work, and has obtained and carefully studied (or assumes responsibility for obtaining and carefully studying) all information that pertains to the

Exhibit A – Required Submission Forms

subsurface or physical conditions at the site or otherwise may affect the cost, progress, performance, or furnishing of the Work, and no additional examinations, investigations, explorations, tests, reports or similar information or data are or will be required by Bidder/Proposer for such purposes.

- 7. Bidder/Proposer further warrants and represents that it has given the City written notice of all errors or discrepancies it has discovered in the Contract and the resolution thereof by the City is acceptable to Bidder/Proposer.
- 8. Bidder/Proposer further warrants and represents that this Bid/Proposal is genuine and not made in the interest of or on behalf of any other undisclosed person, firm or corporation; Bidder/Proposer has not directly or indirectly induced or solicited any other Bidder/Proposer to submit a false or sham Proposal; Bidder/Proposer has not solicited or induced any person, firm or corporation to refrain from submitting; and Bidder/Proposer has not sought by collusion to obtain for itself any advantage over any other Bidder/Proposer or over the City.
- 9. Bidder/Proposer understands that the quantities provided are only provided for proposal evaluation only. The actual quantities may be higher or lower than those in the proposal form.
- 10. Bidder/Proposer understands and agrees that the Contract Price is Unit Rate Contract to furnish and deliver all of the Work complete in place as such the Proposer shall furnish all labor, materials, equipment, tools superintendence, and services necessary to provide a complete Project.

11. Communications concerning this Proposal shall be addressed to:

Bidder/Proposer: _____

Telephone: _____

Email Address: _____

Attention: _____

12. The terms used in this response which are defined in the above-referenced Solicitation shall have the meanings assigned to them in such Solicitation.

STATEMENT

I understand that a "person" as defined in 287.133(1)(e), Florida Statutes, means any natural person or entity organized under the laws of any state or of the United States with the legal power to enter into a binding Contract and which Bids or applies to Bid on Contracts for the provision of goods or services let by a public entity, or which otherwise transacts or applies to transact business with a public entity. The term "persons" includes officers, directors, executives, partners, shareholders, employees, members, and agents active in management of the entity.

SUBMITTED THIS _____ DAY OF _____, 2024.

Company Name: _____

Company Address: _____

Authorized Representative Signature: _____

BID PRICE SHEET

Item	Description	Unit	Qty.	Unit Price	Cost
101-1	MOBILIZATION	LS	1		
102-1	MAINTENANCE OF TRAFFIC	LS	1		
104-18	INLET PROTECTION SYSTEM	EA	4		
110-1-1	CLEARING AND GRUBBING	LS	.0057		
110-4-10	REMOVAL OF EXISTING CONCRETE	SY	50		
334-1-53	SUPERPAVE ASPHALT CONCRETE, TRAFFIC C, PG 76-22	TN	18		
522-1	CONCRETE SIDEWALK AND DRIVEWAYS. 4" THICK	SY	50		
522-2	CONCRETE SIDEWALK AND DRIVEWAYS. 6" THICK	SY	13		
527-2	DETECTABLE WARNINGS	SF	24		
570-1-3	PERFORMANCE TURF, SOD SND SOIL, SHOULDER TREATMENT INDEX 570-XX0	SY	32		
630-2-12	CONDUIT, FURNISH & INSTALL, DIRECTIONAL BORE	LF	2826		
635-2-11	PULL & SPLICE BOX, F&I, 13" X 24" COVER SIZE	EA	52		
639-1-122	ELECTRICAL POWER SERVICE, F&I, UNDERGROUND, METER PURCHASED BY CONTRACTOR	EA	10		
639-2-1	ELECTRICAL SERVICE WIRE, FURNISH & INSTALL	LF	3128		
639-3-11	ELECTRICAL SERVICE DISCONNECT, F&I, POLE MOUNT	EA	10		
641-2-12	PRESTRESSED CONCRETE POLE, F&I, TYPE P-11 SERVICE POLE	EA	10		
700-1-11	SINGLE POST SIGN, F&I GROUND MOUNT, UP TO 12 SF	AS	14		
700-1-60	SINGLE POST SIGN, REMOVE	EA	3		
700-11-131	ELECTRONIC DISPLAY SIGN, F&I GROUND MOUNT – AC POWERED, SPEED FEEDBACK SIGN, UP TO 12 SF	AS	10		
706-1-3	RAISED PAVEMENT MARKERS, TYPE B	EA	24		
711-11-123	THERMOPLASTIC, STANDARD, WHITE, SOLID, 12" FOR CROSSWALK AND ROUNDABOUT	LF	300		
711-11-125	THERMOPLASTIC, STANDARD, WHITE, SOLID, 24" FOR STOP LINE AND CROSSWALK	LF	70		
711-16-201	THERMOPLASTIC, STANDARD-OTHER SURFACES, YELLOW, SOLID, 6"	GM	.086		
711-16-231	THERMOPLASTIC, STANDARD-OTHER SURFACES, YELLOW, SKIP, 6"	GM	.030		

TOTAL BASE BID: _____

Dedicated Allowance (2% of Base Bid) for PERMITTING: _____

Contingency (10% of Base Bid) for UNFORSEEN CONDITIONS: _____

TOTAL BID (Base Bid + Dedicated Allowance + Contingency): _____

NOTE 5% BID BOND MUST BE SEPARATELY SUBMITTED TO CITY CLERK'S OFFICE IN A SEALED ENVELOPE TITLED ITB NO. 2024-09 BEFORE THE SUBMISSION DEADLINE

BIDDER QUALIFICATION STATEMENT

The Bidder’s response to this questionnaire will be utilized as part of the City’s evaluation to ensure that the Bidder meets, to the satisfaction of the City, the minimum requirements for participating in this Solicitation.

PROPOSER MUST PROVIDE DETAILS FULFILLING THE SOLICITATION’S MINIMUM QUALIFICATIONS. FAILURE TO DO SO WILL RESULT IN A DETERMINATION OF NON-RESPONSIVENESS. ADDITIONAL PROJECTS MAY BE ADDED BY COMPLETING ADDITIONAL COPIES OF THIS FORM, AS NEEDED.

Roadway Improvement Project No. 1			
Project Name:			
Project Location:			
Project Description:			
Budget/Cost:		Contract Dates:	
Owner Name:		Reference Name:	
Reference Phone No.:		Reference Email:	
Roadway Improvement Project No. 2			
Project Name:			
Project Location:			
Project Description:			
Budget/Cost:		Contract Dates:	
Owner Name:		Reference Name:	
Reference Phone No.:		Reference Email:	
Roadway Improvement Project No. 3			
Project Name:			
Project Location:			
Project Description:			
Budget/Cost:		Contract Dates:	
Owner Name:		Reference Name:	
Reference Phone No.:		Reference Email:	

LIST OF PROPOSED SUBCONTRACTORS

BIDDER shall list all Proposed Subcontractors to be used on this project if they are awarded the contract.

SCOPE

SUBCONTRACTOR NAME, ADDRESS AND LICENSE #

If, prior to Notice of the Award, the City or the Contractor has reasonable objection to and refuses to accept any Subcontractor, Supplier, person or organization listed, the Contractor may, prior to Notice of Award, submit an acceptable substitute without an increase in their bid price.

BIDDER/PROPOSER AFFIDAVITS

Business Name: _____

D.B.A.: _____ Federal I.D. No.: _____

Business Address: _____

City: _____ State: _____ Zip: _____

I, the undersigned affiant do swear and affirm that I am an authorized agent of the above-named business (“Bidder”) and authorized to make the following statements and certifications on Bidder’s behalf:

1. Ownership Disclosure

Pursuant to City Code Section 2-384, the above-named Bidder hereby discloses the following principals, individuals, or companies with five percent (5%) or greater ownership interest in Bidder (supplement as needed):

<i>Name</i>	<i>Address</i>	<i>% Ownership</i>

The above-named Bidder hereby discloses the following subcontractors (supplement as needed):

<i>Name</i>	<i>Address</i>	<i>% Ownership</i>

Bidder hereby recognizes and certifies that no elected official, board member, or employee of the City of Doral ("City") shall have a financial interest in any transactions or any compensation to be paid under or through any transactions between Bidder and City, and further, that no City employee, nor any elected or appointed officer (including City board members) of the City, nor any spouse, parent or child of such employee or elected or appointed officer of the City, may be a partner, officer, director or proprietor of Bidder, and further, that no such City employee or elected or appointed officer, or the spouse, parent or child of any of them, alone or in combination, may have a material interest in the Bidder. Material interest means direct or indirect ownership of more than 5% of the total assets or capital stock of the Bidder.

Any exception to these above-described restrictions must be expressly provided by applicable law or ordinance and be confirmed in writing by City. Further, Bidder recognizes that with respect to any transactions between Bidder and City, if any Bidder violates or is a party to a violation of the ethics ordinances or rules of the City, the provisions of Miami-Dade County Code Section 2-11.1, as applicable to City, or the provisions of Chapter 112, part III, Fla. Stat., the Code of Ethics for Public Officers and Employees, such Bidder may be disqualified from furnishing the goods or services for which the bid or proposal is submitted and may be further disqualified from submitting any future bids or proposals for goods or services to City. The term "Bidder," as used herein, include any person or entity making a proposal herein to City or providing goods or services to City.

2. Public Entity Crimes

1. Bidder is familiar with and understands the provisions of Section 287.133, Florida Statutes
2. Bidder further understands that a person or affiliate who has been placed on the convicted Bidder list following a conviction for a public entity crime may not submit a bid, proposal, or reply on a contract to provide any goods or services to a public entity; may not submit a bid, proposal, or reply on a contract with a public entity for the construction or repair of a public building or public work; may not submit bids, proposals, or replies on leases of real property to a public entity; may not be awarded or perform work as a contractor, supplier, subcontractor, or consultant under a contract with any public entity; and may not transact business with any public entity in excess of the threshold amount provided in s. 287.017 for CATEGORY TWO for a period of 36 months following the date of being placed on the convicted Bidder list.
3. Based on information and belief, the statement which I have marked below is true in relation to the entity submitting this sworn statement. (**INDICATE WHICH STATEMENT APPLIES.**)
 - _____ Neither the entity submitting this sworn statement, nor any of its officers, directors, executives, partners, shareholders, employees, members, or agents who are active in the management of the entity, nor any affiliate of the entity has been charged with and convicted of a public entity crime subsequent to July 1, 1989.
 - _____ The entity submitting this sworn statement, or one or more of its officers, directors, executives, partners, shareholders, employees, members, or agents who are active in the management of the entity, or an affiliate of the entity has been charged with and convicted of a public entity crime subsequent to July 1, 1989.
 - _____ The entity submitting this sworn statement, or one or more of its officers, directors, executives, partners, shareholders, employees, members, or agents who are active in the management of the entity, or an affiliate of the entity has been charged with and convicted of a public entity crime subsequent to July 1, 1989. However, there has been a subsequent proceeding before a Hearing Officer of the State of Florida, Division of Administrative Hearings and the Final Order entered by the Hearing Officer of the State of Florida, Division of Administrative Hearings and the Final Order entered by the Hearing Officer determined that it was not in the public interest to place the entity submitting this sworn statement on the convicted Bidder list. (Attach a copy of the final order.)

3. Compliance With Foreign Entity Laws

Applicant certifies as follows:

- a. Bidder is not owned by the government of a foreign country of concern, as defined in Section 287.138, Florida Statutes.
- b. The government of a foreign country of concern does not have a controlling interest in Bidder, as defined in Section 287.138, Florida Statutes.
- c. Bidder is not organized under the laws of a foreign country of concern, as defined in Section 287.138, Florida Statutes.
- d. Bidder does not have a principal place of business in a foreign country of concern, as defined in Section 287.138, Florida Statutes.
- e. Bidder is not on the Scrutinized Companies with Activities in Sudan List or the Scrutinized Companies with Activities in Iran Terrorism Sectors List, created pursuant to s. 215.473.
- f. Bidder is not engaged in business operations in Cuba or Syria.
- g. Bidder is not participating in a boycott of Israel, and is not on the Scrutinized Companies that Boycott Israel list in accordance with the requirements of Sections 287.135 and F.S. 215.473, Florida Statutes

4. Disability, Nondiscrimination, and Equal Employment Opportunity

Applicant certifies that Bidder is in compliance with and agrees to continue to comply with, and ensure that any subcontractor, or third party contractor under any and all contracts with the City of Doral complies with all applicable requirements of the laws listed below including, but not limited to, those provisions pertaining to employment, provision of programs and services, transportation, communications, access to facilities, renovations, and new construction.

- The American with Disabilities Act of 1990 (ADA), Pub. L. 101-336, 104 Stat 327, 42 USC 1210112213 and 47 USC Sections 225 and 661 including Title I, Employment; Title II, Public Services; Title III, Public Accommodations and Services Operated by Private entities; Title IV, Telecommunications; and Title V, Miscellaneous Provisions.
- The Florida Americans with Disabilities Accessibility Implementation Act of 1993, Section 553.501 553.513, Florida Statutes.
- The Rehabilitation Act of 1973, 229 USC Section 794.
- The Federal Transit Act, as amended 49 USC Section 1612.
- The Fair Housing Act as amended 42 USC Section 3601-3631

5. Conformance with OSHA Standards

Applicant certifies and agrees that Applicant has the sole responsibility for compliance with all the requirements of the Federal Occupational Safety and Health Act of 1970, and all State and local safety and health regulations, and in the event the City engages Bidder, Bidder agrees to indemnify and hold harmless the City of Doral, against any and all liability, claims, damages losses and expenses the City may incur due to the failure of itself or any of its subcontractors to comply with such act or regulation in the performance of the contract.

6. E-Verify Program Affidavit

Affiant certifies the following:

- a. Affiant is familiar with and understands the provisions of Section 448.095, Florida Statutes and 48 CFR 52.222-54 and has sufficient knowledge of the personnel practices of the Bidder to execute this Declaration on behalf of the Bidder.
- b. Bidder has registered with and utilizes the federal work authorization program commonly known as E-Verify or any subsequent replacement program, in accordance with the applicable provisions and deadlines established in F.S. 448.095, which prohibits the employment, contracting or sub-contracting with an unauthorized alien.
- c. Bidder does not knowingly employ Affiants or retain in its employ a person whose immigration status makes them ineligible to work for the Bidder.
- d. Bidder has verified that any subcontractors utilized to deliver goods or services to the City through the Contractor's contract with the City use the E-Verify system and do not knowingly employ persons whose immigration status makes them ineligible to work for the subcontractor. The undersigned further confirms that it has obtained all necessary affidavits from its subcontractors, if applicable, in compliance with F.S. 448.095, and that such affidavits shall be provided to the City upon request.
- e. Failure to comply with the requirements of F.S. 448.095 may result in termination of the Bidder's contract(s) with the City of Doral.

7. No Contingency Affidavit

Affiant certifies the following:

- a. Neither Bidder nor any principal, employee, agent, representative or family member has promised to pay, and Bidder has not and will not pay, a fee the amount of which is contingent upon the City of Doral awarding a contract.

- b. Bidder warrants that neither it, nor any principal, employee, agent, or representative has procured, or attempted to procure, a contract with the City of Doral in violation of any of the provisions of the Miami- Dade County conflict of interest and code of ethics ordinances.
- c. Bidder acknowledges that a violation of this warranty may result in the termination of any contracts and forfeiture of funds paid, or to be paid, to the Bidder if awarded a contract.

8. Copeland Anti-Kickback Affidavit

Affiant certifies that no portion of any sums will be paid to any employees of the City of Doral, its elected officials, or its consultants, as a commission, kickback, reward or gift, directly or indirectly by Bidder or any member of Bidder's firm or by any officer of the corporation in exchange for business with the City of Doral.

9. Non-Collusion Affidavit

I, the undersigned affiant, swear or affirm that:

- a. Affiant is fully informed respecting the preparation and contents of the attached Bid/Proposal by Contractor and of all pertinent circumstances respecting such Bid/Proposal.
- b. Such Bid/Proposal is genuine and is not a collusive or sham Bid/Proposal.
- c. Neither the said Contractor nor any of its officers, partners, owners, agents, representatives, employees or parties in interest, including Affiant, have in any way colluded, conspired, connived or agreed, directly or indirectly, with any other firm or person to submit a collusive or sham Bid/Proposal in connection with the Work for which the attached Bid/Proposal has been submitted; or to refrain from bidding in connection with such Work; or have in any manner, directly or indirectly, sought by agreement or collusion, or communication, or conference with any firm or person to fix any overhead, profit, or cost elements of the Bid/Proposal or of any other person submitting a response to the solicitation, or to fix any overhead, profit, or cost elements of the quoted price(s) or the quoted price(s) of any other bidding/proposing person, or to secure through any collusion, conspiracy, connivance, or unlawful agreement any advantage against the City or any person interested in the proposed Work.
- d. The price(s) quoted in the attached Bid/Proposal are fair and proper and are not tainted by any collusion, conspiracy, connivance, or unlawful agreement on the part of the Contractor or any other of its agents, representatives, owners, employees or parties in interest, including this Affiant.

10. Drug Free Workplace Program

Bidder, in accordance with Florida statute 287.087 hereby certifies that the Bidder does all of the following:

- a. Publishes a statement notifying employees that the unlawful manufacture, distribution, dispensing, possession, or use of a controlled substance is prohibited in the workplace and specifying the actions that will be taken against employees for violations of such prohibition.
- b. Informs Employees about the dangers of drug abuse in the workplace, the business' policy of maintaining drug-free workplace, any available drug counseling, rehabilitation, and employee assistance programs, and the penalties that may be imposed upon employees for drug abuse violations.
- c. Gives each employee engaged in providing the commodities or contractual services that are under bid a copy of the statement specified in subsection (a).
- d. In the statement specified in subsection (a), notifies the employees that, as a conditions of working on the commodities or contractual services that are under bid, the employee will abide by the terms of the statement and will notify the employer of any conviction of, or plea of guilty or nolo contendere to, any violation of chapter 893 or of any controlled substance law of the United States or any state, for a violation occurring in the workplace no later than five (5) days after such conviction.
- e. Imposes a sanction on, or require the satisfactory participation in, a drug abuse assistance or rehabilitation program if such is available in the employee's community, by any employee who is so convicted.

f. Makes a good faith effort to continue to maintain a drug-free workplace through implementation of this section.

Select here if Not Applicable

11. Cone of Silence Certification

Affiant certifies and that Affiant has read and understands the Cone of Silence” requirements set forth in this Solicitation and further certify that neither I, nor any agent or representative of the Company has violated this provision.

BIDDER AFFIRMATION

I, the undersigned affiant, being first duly sworn as an authorized agent of the below-named Bidder, does hereby affirm and attest under penalty of perjury as the proposed Bidder for City of Doral that the certifications and statements provided above on behalf of Bidder are true to the best of affiant’s knowledge and belief and that Bidder is compliant with all requirements outlined in these City of Doral Affidavits. Bidder acknowledges it is required to comply with and keep current all statements sworn to in the above affidavits and will notify the City of Doral immediately if any of the statements attested hereto are no longer valid.

Bidder Name

Date Signed

Affiant Signature

Affiant Name & Title (Printed)

STATE OF _____
COUNTY OF _____

The foregoing instrument was affirmed, subscribed, and sworn to before me this _____ day of _____, 20__ by means of physical presence or online notarization, by _____ who is personally known to me or who produced the following identification: _____.

[Notary Seal]

Notary Public for the State of _____
My commission expires: _____

CONFLICT OF INTEREST DISCLOSURE

Business Name: _____

D.B.A.: _____ Federal I.D. No.: _____

Business Address: _____

City: _____ State: _____ Zip: _____

Please note that all business entities interested in or conducting business with the City are subject to comply with the City of Doral’s conflict of interest policies as stated within the certification section below. If a vendor has a relationship with a City of Doral official or employee, an immediate family member of a City of Doral official or employee, the vendor shall disclose the information required below.

1. No City official or employee or City employee’s immediate family member has an ownership interest in vendor’s company or is deriving personal financial gain from this contract.
2. No retired or separated City official or employee who has been retired or separated from the City for less than one (1) year has an ownership interest in vendor’s Company.
3. No City employee is contemporaneously employed or prospectively to be employed with the vendor.
4. Vendor hereby declares it has not and will not provide gifts or hospitality of any dollar value or any other gratuities to any City employee or elected official to obtain or maintain a contract.

Conflict of Interest Disclosure*	
Name of City of Doral employees, elected officials, or immediate family members with whom there may be a potential conflict of interest: _____ _____ _____	<input type="checkbox"/> Relationship to employee <input type="checkbox"/> Interest in vendor’s company <input type="checkbox"/> Other (please describe below) _____ _____ <input type="checkbox"/> No Conflict of Interest

**Disclosing a potential conflict of interest does not automatically disqualify vendors. In the event vendors do not disclose potential conflicts of interest and they are detected by the City, vendor will be exempt from doing business with the City.*

I certify that this Conflict-of-Interest Disclosure has been examined by me and that its contents are true and correct to my knowledge and belief and I have the authority to so certify on behalf of the Vendor by my signature below:

Signature of Authorized Representative	Date	Printed Name of Authorized Representative

CERTIFICATE OF AUTHORITY

(IF CORPORATION OR LLC)

I HEREBY CERTIFY that at a meeting of the Board of Directors of _____, a corporation organized and existing under the laws of the State of _____, held on the ___ day of _____, a resolution was duly passed and adopted authorizing _____ (Name) as _____ (Title) of the corporation/company to execute agreements on behalf of the corporation/company and providing that their execution thereof, attested by the secretary of the corporation/company, shall be the official act and deed of the corporation/company. I further certify that said resolution remains in full force and effect.

IN WITNESS WHEREOF, I have hereunto set my hand this ___ day of _____, 20____.

Secretary Signature: _____

Print Name: _____

STATE OF _____

COUNTY OF _____

The foregoing instrument was affirmed, subscribed, and sworn to before me this _____ day of _____, 20____ by means of physical presence or online notarization, by _____ who is personally known to me or who produced the following identification: _____.

[Notary Seal]

Notary Public for the State of _____

My commission expires: _____

CERTIFICATE OF AUTHORITY

(IF PARTNERSHIP)

I HEREBY CERTIFY that at a meeting of the Board of Directors of _____, a partnership organized and existing under the laws of the State of _____, held on the _____ day of _____, _____, a resolution was duly passed and adopted authorizing _____ (Name) as _____ (Title) of the partnership to execute agreements on behalf of the partnership and provides that their execution thereof, attested by a partner, shall be the official act and deed of the partnership. I further certify that said partnership agreement remains in full force and effect.

IN WITNESS WHEREOF, I have hereunto set my hand this _____, day of _____, 20____.

Partner Signature: _____

Print Name: _____

STATE OF _____
COUNTY OF _____

The foregoing instrument was affirmed, subscribed, and sworn to before me this _____ day of _____, 20__ by means of physical presence or online notarization, by _____ who is personally known to me or who produced the following identification: _____.

[Notary Seal]

Notary Public for the State of _____
My commission expires: _____

CERTIFICATE OF AUTHORITY

(IF JOINT VENTURE)

Joint ventures must submit a joint venture agreement indicating that the person signing this Agreement is authorized to sign documents on behalf of the joint venture. If there is no joint venture agreement, each member of the joint venture must sign this Agreement and submit the appropriate Certificate of Authority (corporate, partnership, or individual).

TRENCH SAFETY FORM

Bidder acknowledges that the Florida Trench Safety Act, Section 553.60 et seq, Fla. Stat. which became effective October 1, 1990, shall be in effect during the period of construction of the Project. The Bidder by signing and submitting the Bid is, in writing, assuring that it will perform any trench excavation in accordance with applicable trench safety standards. The Bidder further identifies the following separate item of cost of compliance with the applicable trench safety standards as well as the method of compliance:

Method of Compliance

Cost

Total: \$ _____

Bidder acknowledges that this cost is included in the applicable items of the Bid and in the Total Base Bid. Failure to complete the above may result in the bid being declared non-responsive.

The Bidder is, and the CITY and ENGINEER are not, responsible to review or assess Bidder’s safety precautions, programs of costs, of the means, methods, techniques or technique adequacy, reasonableness of cost, sequences of procedures of any safety precaution, program or cost, including but not limited to, compliance with any and all requirements of Section 553.60 et. seq., Fla. Stat. cited as the “Trench Safety Act”. Bidder is, and the CITY and ENGINEER are not, responsible to determine, if any safety or safety related standards apply to the Project, including but not limited to, the “Trench Safety Act”.

Witness Signature

Bidder’s Signature

Printed Name

Printed Name

Date

Title

Date

CONSTRUCTION CONTRACT

This Contract (the “Contract”) is dated as of the _____ day of _____ 20____ by and between the City of Doral (hereinafter called the “CITY”) and _____ (hereinafter called “CONTRACTOR”) located at: _____ CITY and CONTRACTOR, in consideration of the mutual covenants hereinafter set forth, agree as follows:

ARTICLE 1 – WORK

1.1 Project/Work: CONTRACTOR shall complete all Work as specified or indicated in the Contract Documents, which is hereinafter defined to mean this Contract, ITB No. 2023 Section 7 Traffic Calming Improvements (“ITB”), and the various documents set forth in Article 8 below.

ARTICLE 2 – CITY’S REPRESENTATIVE, ARCHITECT AND ENGINEER

2.1 It is understood that the CITY will designate a representative for the Work. The CITY’S REPRESENTATIVE referred to in any of the Contract Documents designated herein is **Carlos Arroyo, Public Works Director**, at City of Doral Government Center, 8401 NW 53rd Terrace Doral, Florida 33166.

2.2 The CITY’S ENGINEER referred to in any of the Contract Documents is hereby designated to be **Manuel A. Sauleda, P.E.**, at H. W. Lochner, Inc., 8750 NW 36th Street-Suite #300, Doral, Florida 33178 for the design of Section 7 Traffic Calming Improvements or such other individual designated by the City.

ARTICLE 3 – TERM

3.1 Contract Times. Contract Time will commence on the date the specified in the Notice to Proceed and shall continue for a period of **one hundred and eighty (180) calendar days**. The Work shall be completed and shall be ready for final payment in accordance with the Contract Documents within one hundred and eighty (180) calendar days after the date specified in the Notice to Proceed (“Final Completion”). No extension of time will be given unless previously provided by Change Order. Liquidated damages will be assessed for each calendar day for which completion of the Work is delayed as set forth in Section 3.4.

3.2 Term. This Contract shall not be effective until it is fully executed between the CITY and the CONTRACTOR. The term of the Contract shall be through the date of final payment unless terminated earlier pursuant to the ITB, or otherwise agreed upon between the parties.

3.3 Survival of Obligations. Any obligations by the CONTRACTOR, including but not limited to those set forth in the ITB, that would or could occur after the date of expiration or termination of the Contract shall survive the termination or expiration of the Contract.

3.4 Liquidated Damages. CITY and CONTRACTOR recognize that time is of the essence in this Contract and that the CITY will suffer financial loss if the Work is not completed within the contract times specified in Section 3.1 for the Work above, plus any approved extensions thereof allowed in accordance with the ITB. The CONTRACTOR also recognizes the delays, expense and difficulties involved in proving the actual loss suffered by CITY if the Work is not completed on time. Accordingly, instead of requiring any such proof, CITY and CONTRACTOR agree that as liquidated damages for delay (but not as a penalty) CONTRACTOR shall pay CITY **\$1,665.00** for each calendar day that expires after the time specified in Section 3.1 for Substantial Completion

of the Work. After Final Completion, if CONTRACTOR shall neglect, refuse or fail to complete the remaining Work within the time specified in Section 3.1 for completion and readiness for final payment or any proper extension thereof granted by CITY, CONTRACTOR shall pay CITY **\$1,665.00** for each calendar day that expires after the time specified in Section 3.1 for completion and readiness for final payment.

3.5 Should the Final Completion and acceptance of Work, together with any modification or additions, be delayed beyond the time for performance set in Section 3.1 above because of lack of performance by the CONTRACTOR, it is understood and agreed that aside from any other liquidated damages, all actual additional costs or losses incurred by the CITY including, but not limited to, completion CONTRACTOR services, financing, professional services, unrealized revenue, will be the responsibility of the CONTRACTOR.

3.6 Monies due to the CITY under Sections 3.4 and 3.5 shall be deducted from any monies due the CONTRACTOR, or if no money is due or the amount due is insufficient to cover the amount charged the CONTRACTOR shall be liable for said amount.

ARTICLE 4 – CONTRACT PRICE

4.1 CITY shall pay CONTRACTOR for completion of the Work in accordance with the Contract Documents an amount in current funds equal to the sum of the amounts determined pursuant to this Article.

4.2 For all Unit Price Work, an amount equal to the sum of the established unit price for each separately identified item of Unit Price Work times the estimated quantity of that item as indicated on the Unit Price Bid Form Section 00410. Estimated quantities are not guaranteed, and determination of actual quantities and classification are to be made by ENGINEER as provided in the Contract Documents.

4.3 The CONTRACTOR agrees that all specific cash allowances are included in the above Contract Price and have been computed in accordance with the Contract Documents.

4.4 A cost breakdown (schedule of values) shall be submitted to the Engineer by the CONTRACTOR for approval by the Engineer within seven days after notification of award of Contract. The schedule of values shall be used as the basis for making progress payments and for determining the cost of extra work where the extra work is an increase in the quantity of work included in the cost breakdown. The cost breakdown shall be complete, with each item of materials, equipment and supplies listed, together with the quantity and price thereof, the sum of which shall be equal to the aggregate sum prices bid for "materials, equipment and supplies". The breakdown shall include a separate column of figures which shall be the cost of installation of the above items, which cost shall include prorated share of bonds, insurance, overhead and profit. The sum of this second column of figures shall be equal to the aggregate sum prices bid for "all other costs incurred in completing the project". Any item(s), as determined by the City to be unbalanced, will not be acceptable.

4.5 The CONTRACTOR shall retain a copy of the cost breakdown in their files for reference purposes.

ARTICLE 5 – PAYMENT PROCEDURES

5.1 CONTRACTOR shall submit Applications for Payment in accordance with the ITB. Applications for Payment will be processed by CITY as provided in the ITB.

5.2 Progress Payments, Retainage. CITY shall make progress payments, deducting the amount from the Contract Price above, on the basis of CONTRACTOR'S Applications for Payment as recommended by the CITY'S REPRESENTATIVE, on or about the last day of each month during construction as provided herein. All such payments will be made in accordance with the schedule of values established in the ITB or, in the event there is no schedule of values, as provided in the ITB.

5.2.1 Commencing with Pay Requisition #2, no progress payment shall be made until CONTRACTOR delivers to the CITY (1) complete original partial releases of all liens and claims signed by all Subcontractors, materialmen, suppliers, and vendors, indicating amount of partial payment, on a City of Doral Release of Lien Form (Exhibit ____), and an affidavit that so far as the CONTRACTOR has knowledge or information, the releases include and cover all Materials and Work for which a lien or claim could be filed for work completed to date, or (2) an executed Consent of Surety, utilizing City of Doral "Consent of Surety for Payment" Form (Exhibit ____). CONTRACTOR shall also provide a partial release of lien as Prime CONTRACTOR utilizing City of Doral Form (Exhibit ____). CONTRACTOR shall also include red-line as-builts and an updated progress schedule.

5.3 The CONTRACTOR agrees that five percent (5%) of the amount due for Work as set forth in each Application for Payment shall be retained by CITY for each Progress Payment until Final Payment, as defined in the ITB.

5.3.1 Prior to Substantial Completion, progress payments will be made in an amount equal to the percentage indicated above, but, in each case, less the aggregate of payments previously made and less such amounts as CITY'S REPRESENTATIVE shall determine, or CITY may withhold, in accordance with the ITB.

5.4 The payment of any Application for Payment by CITY, including the Final Request, does not constitute approval or acceptance by CITY of any item of the Work in such Request for Payment, nor shall it be construed as a waiver of any of CITY's rights hereunder or at law or in equity.

5.5 The Final Application for Payment by CONTRACTOR shall not be made until the CONTRACTOR delivers to the CITY complete original releases of all liens and claims signed by all Subcontractors, materialmen, suppliers, and vendors on a City of Doral Release of lien Form (Exhibit ____), and an affidavit that so far as the CONTRACTOR has knowledge or information, the releases include and cover all Materials and Work for which a lien or claim could be filed. The CONTRACTOR shall also provide a final release of lien as Prime CONTRACTOR utilizing City of Doral Form (Exhibit ____). The CONTRACTOR may, if any Subcontractor, materialmen, supplier or vendor refuses to furnish the required Final Waiver of Lien, furnish a bond satisfactory to CITY to defend and indemnify CITY and any other property Owner, person or entity CITY may be required to indemnify against any lien or claim.

5.6 Final Payment. Upon final completion and acceptance of the Work in accordance with the ITB, CITY shall pay the remainder of the Contract Price and any retainage as recommended by the CITY'S REPRESENTATIVE.

ARTICLE 6 – INSURANCE/INDEMNIFICATION.

6.1 Insurance.

6.1.1 The CONTRACTOR shall provide and maintain in force until all the Work to be performed under this Contract has been completed and accepted by City (or for such duration as is otherwise specified hereinafter), the insurance coverage set forth: in Exhibit ____ titled Insurance Requirements.

6.1.2 The CONTRACTOR agrees that if any part of the Work under the Contract is sublet, they will require the Subcontractor(s) to carry insurance as required, and that they will require the Subcontractor(s) to furnish to them insurance certificates similar to those required by the CITY.

6.1.3 If any insurance should be canceled or changed by the insurance company or should any insurance expire during the period of this contract, the CONTRACTOR shall be responsible for securing other acceptable insurance to provide the coverage specified in this section to maintain coverage during the life of this Contract.

6.1.4 All deductibles must be declared by the CONTRACTOR and must be approved by the CITY. At the option of the CITY, either the CONTRACTOR shall eliminate or reduce such deductible, or the CONTRACTOR shall procure a Bond, in a form satisfactory to the CITY, covering the same. The CONTRACTOR is responsible for any and all deductibles, if applicable, following a loss.

6.2 Indemnification. The CONTRACTOR shall indemnify, defend and hold harmless the CITY, their officials, agents, employees, and volunteers as set forth in the Contract Documents.

ARTICLE 7 – CONTRACTOR'S REPRESENTATIONS.

In order to induce CITY to enter into this Contract, CONTRACTOR makes the following representations:

7.1 CONTRACTOR has examined and carefully studied the Contract Documents (including the Addenda) and the other related data identified in the Bidding Documents including “technical data.”

7.2 CONTRACTOR has visited the site and become familiar with and is satisfied as to the general, local and site conditions that may affect cost, progress, performance or furnishing of the Work.

7.3 CONTRACTOR is familiar with and is satisfied as to all federal, state and local Laws and Regulations that may affect cost, progress, performance and furnishing of the Work.

7.4 CONTRACTOR has made, or caused to be made, examinations, investigations, tests, or studies as necessary to determine surface and subsurface conditions at or on the site. CONTRACTOR acknowledges that CITY does not assume responsibility for the accuracy or

completeness of information and data shown or indicated in the Contract Documents with respect to underground facilities at or contiguous to the site. CONTRACTOR has obtained and carefully studied (or assumes responsibility for having done so) all such additional supplementary examinations, investigations, explorations, tests, studies and data concerning conditions (surface, subsurface and Underground Facilities) at or contiguous to the site or otherwise which may affect cost, progress, performance or furnishing of the Work or which relate to any aspect of the means, methods, techniques, sequences and procedures of construction to be employed by CONTRACTOR and safety precautions and programs incident thereto. CONTRACTOR does not consider that any additional examinations, investigations, explorations, tests, studies or data are necessary for the performance and furnishing of the Work at the Contract Price, within the Contract Times and in accordance with the other terms and conditions of the Contract Documents.

7.5 The CONTRACTOR is aware of the general nature of Work to be performed by CITY and others at the site that relates to the Work as indicated in the Contract Documents.

7.6 The CONTRACTOR has correlated the information known to CONTRACTOR, information and observations obtained from visits to the site, reports and drawings identified in the Contract Documents and all additional examinations, investigations, explorations, tests, studies and data with the Contract Documents.

7.7 The CONTRACTOR has given the CITY'S REPRESENTATIVE written notice of all conflicts, errors, ambiguities or discrepancies that CONTRACTOR has discovered in the Contract Documents and the written resolution thereof by the CITY'S REPRESENTATIVE is acceptable to CONTRACTOR, and the Contract Documents are generally sufficient to indicate and convey understanding of all terms and conditions for performance and furnishing of the Work.

7.8 The CONTRACTOR warrants the following:

7.8.1 Anti-Discrimination: The CONTRACTOR agrees that it will not discriminate against any employees or applicants for employment or against persons for any other benefit or service under this Contract because of race, color, religion, sex, national origin, or physical or mental handicap where the handicap does not affect the ability of an individual to perform in a position of employment, and to abide by all federal and state laws regarding non-discrimination.

7.8.2 Anti-Kickback: The CONTRACTOR warrants that no person has been employed or retained to solicit or secure this Contract upon an agreement or understanding for a commission, percentage, brokerage or contingent fee, and that no employee or officer of the CITY or any other applicable federal or state agency, has any interest, financially or otherwise, in the Project. For breach or violation of this warranty, the CITY shall have the right to annul this Contract without liability or, in its discretion, to deduct from the Contract Price or consideration, the full amount of such commission, percentage, brokerage or contingent fee.

7.8.3 Licensing and Permits: The CONTRACTOR warrants that it shall have, prior to commencement of work under this Contract and at all times during said work, all required licenses and permits whether federal, state, County or City.

7.8.4 Public Entity Crime Statement: The CONTRACTOR warrants that it has not been placed on the convicted vendor list following a conviction for public entity crime, as specified in Section 00456, of the Instructions to Bidders.

ARTICLE 8 – CORRELATION, INTERPRETATION, AND INTENT OF CONTRACT DOCUMENTS.

8.1 All Contract Documents shall be interpreted in a manner consistent with each other, provided that if there are differing provisions on the same subject matter, the more stringent requirements shall apply

8.2 The Contract Documents listed below, which are listed in their order of precedence for the purpose of resolving conflicts, errors and discrepancies, by this reference shall become a part of the Contract as though physically attached as a part thereof:

8.2.1 Change Orders.

8.2.2 Field Orders.

8.2.3 Contract for Construction.

8.2.4 Exhibits to this Contract.

8.2.5 Any federal, state, county or City permits for the Project

8.2.6 Specifications and Drawings provided

8.2.7 Bid Documents, including but not limited to: Addendum, Invitation to Bid, Instructions to Bidders, Bid Form provided by CONTRACTOR, Notice of Award and Notice to Proceed.

8.2.8 Addenda subject matter takes the same precedence of the respective subject matter that it is modifying. Furthermore, each subsequent addendum takes precedence over previous addenda.

8.2.9 The documents listed above shall be incorporated into this Contract (except as expressly noted otherwise above).

8.2.10 There are no Contract Documents other than those listed above in this Article. The Contract Documents may only be amended, modified or supplemented as provided in the ITB.

8.2.11 The Contract Documents shall remain the property of the CITY. The CONTRACTOR shall have the right to keep one record set of the Contract Documents upon completion of the Project; provided; however, that in no event shall the CONTRACTOR use, or permit to be used, any or all of such Contract Documents on other projects without the City's prior written authorization.

8.2.12 The ITB discuss the bond and surety requirements of the CITY. This Contract does , does not require bonds. If the Contract does not require bonds, the references to bonds in the ITB do not apply to this Contract.

ARTICLE 9 – MISCELLANEOUS

9.1 Terms used in this Contract which are defined in the ITB will have the meanings indicated therein.

9.2 Except as otherwise provided in the Contract Documents with respect to Subcontractors, no assignment by a party hereto of any rights under or interests in the Contract Documents will be binding on another party thereto without the written consent of the party sought to be bound; and, specifically but without limitation, moneys that may become due and moneys that are due may not be assigned without such consent (except to the extent that the effect of this restriction may be limited by law), and unless specifically stated to the contrary in any written consent to an assignment no assignment will release or discharge the assignor from any duty or responsibility under the Contract Documents.

9.3 CITY and CONTRACTOR each binds itself, its partners, successors, assigns and legal representatives to the other party hereto, its partners, successors, assigns and legal representatives in respect to all covenants, agreements and obligations contained in the Contract Documents.

9.4 Severability. Should any provision, paragraph, sentence, word, or phrase contained in this Contract be determined by a court of competent jurisdiction to be invalid, illegal, or otherwise unenforceable under the laws of the State of Florida, such provision, paragraph, sentence, word, or phrase shall be deemed modified to the extent necessary in order to conform with such laws or shall be deemed severable and this Contract, shall remain unmodified and in full force and effect.

9.5 Remedies. If and when any default of this Contract occurs, the CITY may avail itself of any legal or equitable remedies that may apply, including, but not limited to, actual damages and specific performance. Such remedies may be exercised in the sole discretion of the CITY. Nothing contained in this Contract shall limit the CITY from pursuing any legal or equitable remedies that may apply.

9.6 Access to Public Records. The CONTRACTOR shall comply with the applicable provisions of Chapter 119, Florida Statutes. The CITY shall have the right to immediately terminate this contract for the refusal by the CONTRACTOR to comply with Chapter 119, Florida Statutes. The CONTRACTOR shall retain all records associated with this Contract for a period of five (5) years from the date of Final Payment or Termination of this Contract.

9.7 Inspection and Audit. During the term of this Contract and for five (5) years from the date of Termination, the CONTRACTOR shall allow CITY representatives access during reasonable business hours to CONTRACTOR'S records related to this Contract for the purposes of inspection or audit of such records. If upon an audit of such records, the CITY determines the CONTRACTOR was paid for services not performed, upon receipt of written demand by the CITY, the CONTRACTOR shall remit such payments to the CITY.

9.8 Night work or weekend work may be required for various areas within the project limits. The CONTRACTOR is responsible for costs associated with all night work including but not limited to, inspector costs, police or flagmen costs, signage and MOT costs and all other costs associated with night or weekend work.

All connections to existing piping systems shall be made as shown or indicated on the Drawings after consultation, cooperation, and coordination with the Owner. Some such connections may have to be made during off-peak hours (late night, early morning, or weekend hours). The CONTRACTOR shall give a minimum of 72 hours' notice to the Owner when tie-ins with the existing plant utilities are required.

9.8.1 For weekend work, CONTRACTOR shall submit a written request to the CITY by the preceding Wednesday. A separate request is required for each week that the CONTRACTOR wishes to work on a weekend. For evening and holiday work, CONTRACTOR shall submit a written request to the CITY 3 days in advance. The CITY will provide inspection services for all overtime work requests and the CONTRACTOR shall pay for inspection services, no exceptions. Similarly, holiday and other overtime work shall be requested a minimum of 36-hours in advance and CITY will provide inspection for all overtime.

9.8.2 Exceptions to the hours and days of the week for work and other related limitations are allowed only for tie-ins during low flow periods / early morning hours, coatings that need to be applied during lower temperature times of the day and whenever the Documents specifically define that work shall be completed outside of the limitations for “normal” work hours, days, etc. Inspection for tie-ins during low flow/early morning and specialty coating application performed during nighttime will not be cause for extra inspection costs unless such work is remedial in nature as a result of defective work.

9.9 E-VERIFY. Section 448.095, Florida Statutes directs all public employers, including municipal governments, and private employer with 25 or more employees to verify the employment eligibility of all new employees through the U.S. Department of Homeland Security’s E-Verify System, and further provides that a public entity may not enter into a contract unless each party to the contract registers with and uses the E-Verify system. Section 448.095, Florida Statutes further provides that if a Contractor enters into a contract with a subcontractor, the subcontractor must provide the Contractor with an affidavit stating that the subcontractor does not employ, contract with, or subcontract with an unauthorized alien. In accordance with Section 448.095, Florida Statutes, CONTRACTOR, if it employs more than 25 employees, is required to verify employee eligibility using the E-Verify system for all existing and new employees hired by CONTRACTOR during the contract term. Further, CONTRACTOR must also require and maintain the statutorily required affidavit of its subcontractors. It is the responsibility of CONTRACTOR to ensure compliance with E-Verify requirements (as applicable). To enroll in E-Verify, employers should visit the E-Verify website (<https://www.e-verify.gov/employers/enrolling-in-e-verify>) and follow the instructions.

9.10 Prohibition Against Contracting with Scrutinized Companies. Pursuant to Florida Statutes Section 217.4725, the City is prohibited from contracting with any entity that is listed on the Scrutinized Companies that Boycott Israel List or that is engaged in the boycott of Israel is prohibited. By entering into this Agreement, CONTRACTOR is certifying that the company is not participating in a boycott of Israel. Any contract for goods or services of One Million Dollars (\$1,000,000) or more shall be terminated at the City’s option if it is discovered that the entity submitted false documents of certification, is listed on the Scrutinized Companies with Activities in Sudan List, the Scrutinized Companies with Activities in the Iran Petroleum Energy Sector List or has been engaged in business operations in Cuba or Syria after July 1, 2018.

Any contract entered into or renewed after July 1, 2018 shall be terminated at the City’s option if the company is listed on the Scrutinized Companies that Boycott Israel List or engaged in the boycott of Israel. By entering into this Agreement, CONTRACTOR is certifying that it does not participate in a boycott of Israel, is not on the scrutinized companies that Boycott Israel list, activities in Sudan List, in the Iran Petroleum Energy Secor list, and has not engaged in business operation in Cuba or Syria. Submitting a false certification shall be deemed a material breach of contract. The City shall provide notice, in writing, to the CONTRACTOR of the City’s determination concerning the false certification. The CONTRACTOR shall have ninety (90) days following receipt of the notice to respond in writing and demonstrate that the determination was in error. If the CONTRACTOR does not demonstrate that the City’s determination of false certification was made in error, then the City shall have the right to terminate the contract and seek civil remedies pursuant to Florida Statute Section 215.4725.

9.11 Counterparts. This contract may be signed in one or more counterparts, each of which when executed shall be deemed an original and together shall constitute one and the same instrument.

9.12 Notices. Whenever any party is required to give or deliver any notice to any other party, or desires to do so, such notices shall be sent via certified mail or hand delivery to:

FOR CITY: City Manager
City of Doral
8401 NW 53rd Terrace
Doral, Florida 33166

WITH COPY TO: City Attorney
City of Doral
8401 NW 53rd Terrace
Doral, Florida 33166

FOR CONTRACTOR:

9.13 WAIVER OF JURY TRIAL AND VENUE. The CITY and CONTRACTOR knowingly, irrevocably, voluntarily and intentionally waive any right either may have to a trial by jury in State and or Federal court proceedings in respect to any action, proceeding, lawsuit or counterclaim based upon the Contract, arising out of, under, or in connection with the Work, or any course of conduct, course of dealing, statements or actions or inactions of any party. The venue for any lawsuit arising out of this Contract shall be in Miami-Dade County, Florida.

9.14 Attorneys' Fees. If either the CITY or CONTRACTOR is required to enforce the terms of the Contract by court proceedings or otherwise, whether or not formal legal action is required, the prevailing party shall be entitled to recover from the other party all such costs and expenses, including, but not limited to, court costs, and reasonable attorneys' fees at the trial and appellate level.

9.15 Amendments. This Contract may only be amended by the prior written approval of the parties or by execution of a Change Order in the form attached hereto as Exhibit "_____".

IN WITNESS WHEREOF, the parties hereto have made and executed this Contract on the respective dates under each signature: THE CITY OF DORAL, FLORIDA, signing by and through its City Manager, authorized to execute same by Council action on the _____ day of _____ 20____, and _____ by _____ (CONTRACTOR), signing by _____ and through its _____, duly authorized to execute same.

WITNESS
By:
(Signature and Corporate Seal)

CONTRACTOR
(CONTRACTOR)

(Print Name and Title)

(Signature)

(Print Name and Title)

day of , 20 .

ATTEST

CITY OF DORAL

Connie Diaz, City Clerk

City Manager

APPROVED AS TO FORM AND LEGALITY FOR THE USE
AND BENEFIT OF THE CITY OF DORAL ONLY:

GREENSPOON MARDER, LLP
City Attorney

(In the event that the CONTRACTOR is a corporation, there shall be attached to each counterpart a certified copy of a resolution of the board of the corporation, authorizing the officer who signs the contract to do so in its behalf.*

DRAFT

MINIMUM INSURANCE REQUIREMENTS

I. Commercial General Liability

A. Limits of Liability	
Bodily Injury & Property Damage Liability	
Each Occurrence	\$2,000,000
Policy Aggregate (Per job or project)	\$4,000,000
Personal & Advertising Injury	\$1,000,000
Products & Completed Operations	\$4,000,000

B. Endorsements Required

City of Doral listed as an additional insured.
 Contingent & Contractual Liability
 Premises and Operations Liability
 Primary Insurance Clause Endorsement
 Explosion, Collapse & Underground Hazard

Waiver of Subrogation in favor of City

II. Business Automobile Liability

A. Limits of Liability	
Bodily Injury and Property Damage	
Combined Single Limit	
Any Auto/Owned Autos or Scheduled Autos	
Including hired and Non-Owned Autos	
Any One Accident	\$1,000,000

B. Endorsements Required

City of Doral listed as an additional insured

III. Workers Compensation

Statutory- State of Florida

Employer’s Liability

A. Limits of Liability
 \$1,000,000 for bodily injury caused by an accident, each accident.
 \$1,000,000 for bodily injury caused by disease, each employee.
 \$1,000,000 for bodily injury caused by disease, policy limit.
 Workers Compensation insurance must be provided for all persons fulfilling this contract, whether employed, contracted, temporary or subcontracted.

V. Umbrella/Excess Liability (Excess Follow Form) can be utilized to provide the required limits. Coverage shall be “following form” and shall not be more restrictive than the

underlying insurance policy coverages, including all special endorsements and City as Additional Insured status.

Subcontractors' Compliance: It is the responsibility of the CONTRACTOR to ensure that all Subcontractors comply with all insurance requirements.

All above coverage must remain in force and Certificate of Insurance on file with City without interruption for the duration of this agreement. Policies shall provide the City of Doral with 30 days' written notice of cancellation or material change from the insurer. If the policies do not contain such a provision, it is the responsibility of the CONTRACTOR to provide such notice within 10 days of the change or cancellation.

Certificate Holder: City of Doral, Florida
8401 NW 53rd Terrace
Doral, FL 33166

Certificates/Evidence of Property Insurance forms must confirm insurance provisions required herein. Certificates shall include Agreement, Bid/Contract number, dates, and other identifying references.

Insurance Companies must be authorized to do business in the State of Florida and must be rated no less than "A-" as to management, and no less than "Class V" as to financial strength, by the latest edition of AM Best's Insurance Guide, or its equivalent.

Coverage and Certificates of Insurance are subject to review and verification by City of Doral Risk Management. City reserves the right but not the obligation to reject any insurer providing coverage due to poor or deteriorating financial condition. The City reserves the right to amend insurance requirements in order to sufficiently address the scope of services. These insurance requirements shall not limit the liability of the CONTRACTOR/Vendor. The City does not represent these types or amounts of insurance to be sufficient or adequate to protect the CONTRACTOR/Vendor's interests or liabilities but are merely minimums.

PRECONSTRUCTION CONFERENCE

After award and prior to the issuance of the "Notice to Proceed", a preconstruction conference will be held with representatives from the awarded Bidder, CEI Team, Engineering Team, City of Doral, various utility companies, and other stakeholders, for the purpose of coordinating the Work. The City will discuss requirements of such matters as project supervision and inspections, progress schedules and reports, Contract Change Orders, insurance, safety, and other items pertinent to the Project. The time and place of the meeting shall be set by the City's project manager.

In some cases, the preconstruction conference may be held after the start work date stated in the written "Notice to Proceed". This may be due to difficulty with coordination of all parties concerned, or other similar reasons. Such delays in holding the preconstruction meeting shall not relieve the Contractor of any responsibilities hereunder and will not be an acceptable reason for him to request additional work completion time beyond that provided since he will be able to begin obtaining permits, mobilizing his equipment and forces, preparing submittals, ordering materials, performing minor work, or other work if approved by the Engineer, during the interim period.

Prior to the preconstruction conference, the Contractor shall prepare the construction schedule and provide copies of the same to others in attendance. The construction schedule shall include the place of beginning, the proposed order of progression, together with the estimated times for beginning and completing the various items of work. In addition, the Contractor shall prepare on electronic media, a critical path method (CPM) with emphasis made to "construction time and completion", Early/Late Start, Early/Late Finish, and clearly present Float Time as associated with activity and project duration with no activity duration longer than 4 calendar weeks unless approved by the Engineer.

The City shall discuss requirements of such matters as description of project, Contract important dates, project contact information, permitting, site and location access, utility coordination, maintenance of traffic (MOT), review of plans and special requirements, testing requirements, erosion control, project supervision and inspections, progress schedules and reports, Contract Change Orders, insurance, safety, special provisions, warranty and other items pertinent to the Project.

All parties to this conference shall be prepared to discuss any problems anticipated with the execution of the Work under this Contract. Contractor will be presented with a link to the copy of the preconstruction power point and a hard copy for his/her execution.

The following submittals will be required from the Contractor at Preconstruction Conference

- i. Construction Schedule
- ii. Pre-Construction photos and video
- iii. Chain of Authority letter
- iv. Hurricane Preparedness Plan (Site Specific)
- v. Emergency Contact Information letter
- vi. Competent Person Information letter
- vii. Labor Burden Declaration letter (Exhibit K) from CPA

SITE CONDITIONS

SITE INVESTIGATION AND REPRESENTATION

The Contractor acknowledges that he has satisfied himself as to the nature and location of the work, the general and local conditions, particularly those bearing upon availability of transportation; disposal, handling and storage of materials; availability of labor, water, electric power, roads; disposal of water from construction; uncertainties of weather; the conformation and conditions at the ground; the type of equipment and facilities needed preliminary to and during the prosecution of the work and all other matters which can in any way affect the work or the cost thereof under this Contract.

The Contractor further acknowledges that he has satisfied himself as to the character, quality, and quantity of surface and subsurface materials to be encountered from inspecting the site, making whatever site investigations he deems diligent or prudent, and from evaluating information derived from exploratory work that may have been done by the City of Doral or included with these Contract Documents. Any failure by the Contractor to acquaint himself with all the available information will not relieve him from responsibility for properly estimating the difficulty or cost thereof under this Contract.

The Contractor acknowledges that by personal field observation or other means satisfactory to himself, performed prior to the Bid, he has included in the prices bid all costs for dealing with all construction problems created by observable above or on grade features on or adjacent to the site of the work whether or not these features are shown on the Plans or described in the Specifications. In instances where the observable features indicate subsurface conditions which may affect the Project work, as for example, a pavement patch or catch basin gratings indicating respectively a utility or storm sewer not shown on the Plans, the Contractor acknowledges that he has made timely, diligent, inquiry of the Engineer or by other means fully satisfied himself prior to the Bid as to the nature of, and costs created by, the subsurface condition and included all costs therefore in the prices bid.

INFORMATION ON SITE CONDITIONS

All information obtained by the City of Doral regarding the site conditions, topography, subsurface information, ground water elevations, existing construction of site facilities as applicable, and similar data will be available for inspection at the office of the Engineer upon request. Such information is offered as supplementary information only. Neither the Engineer nor the City of Doral assumes any responsibility for the completeness or for the Contractor's interpretation of such supplementary information. The interpretation of the record and the conclusions drawn there from as to the actual existence of surface conditions are the sole responsibility of the Contractor. Prior to bidding and after written approval from the City of Doral, the bidder may make his own survey investigations to satisfy himself with site conditions at his own cost. Any estimates of quantities of work or materials, based on set borings, test excavations and other subsurface investigations are not warranted by the City to indicate the true conditions or distribution of quantities unless the Contractor is expressly directed to rely on such information to prepare and submit his Bid.

SUBSURFACE INFORMATION

Subsurface investigations, including test borings, have been made to indicate subsurface conditions at particular locations. All information regarding subsurface conditions and all available soil samples recovered from test borings at the project site that the City of Doral may have, may be examined by all prospective bidders prior to the receipt of proposals. Appointment for the examination of such information or soil samples shall be made with the City of Doral.

BORING LOG

A log of test borings showing a record of the data obtained on subsurface conditions is included in the Contract Documents as an Appendix and is for reference only. All such information was prepared for the information of the City of Doral's engineers only for design purposes and is not to be considered as a part of the Contract Documents.

BIDDERS SUBSURFACE INVESTIGATION

Prospective bidders are advised, at their own expense, to make such subsurface investigation, by boring or test hole excavation, as may be desirable. However, such work is to be scheduled by appointment with the Engineer if on a City of Doral site or by notification to the City of Doral.

DIFFERING SUBSURFACE CONDITIONS

In the event subsurface or latent physical conditions are found materially different from those indicated in these Documents, and differing materially from those ordinarily encountered and generally recognized as inherent in the character of work covered in these Contract Documents, promptly, and before such conditions are disturbed, notify the Engineer in writing of such changed conditions.

The Engineer and/or the Engineer of Record will investigate such conditions promptly and following this investigation, the Contractor shall proceed with the work, unless otherwise instructed by the Engineer. If the Engineer and/or the Engineer of Record find that such conditions do so materially differ as to cause an increase or decrease in cost and time considered reasonable by the Engineer, the City of Doral will make the final decision regarding any adjustment in cost or time for completion.

In the event that site conditions differ from those expected by the Contractor, the Contractor shall proceed to complete the work as contemplated by the Plans and Specifications at his own cost and expense. If in the discretion of the Engineer, the difference in site conditions renders completion of the work as described by the Plans and Specifications impossible, the Engineer may alter the work, in accordance with the terms of the Solicitation, whereupon the Contractor shall be compensated for any extra work pursuant to the terms of the Solicitation; the Engineer shall not alter the work where the site conditions render the work more difficult or costly to perform, if such work is otherwise still possible as described in the Contract Documents.

EXISTING UTILITIES AND LOCATION SERVICES

Known utilities and structures adjacent to or encountered in the work are shown on the Drawings. The locations shown are taken from existing records and the best information available from existing plans; however, it is expected that there may be some discrepancies and omissions in the locations and quantities of utilities and structures shown. Those shown are for the convenience of the Contractor only, and no responsibility is assumed by the City of Doral, the Engineer, and/or the Engineer of Record for their accuracy or completeness.

No request for additional compensation or Contract time (except for a non-compensable time extension at the sole discretion of the Engineer, whose decision shall be final) resulting from encountering utilities or structures not shown, or differing in location or elevation from that shown, will be considered. The Contractor shall explore sufficiently ahead of the Work to allow time for any necessary adjustments without delay to the progress of the installation. Costs due to delays occasioned by encountering underground utilities or structures which could have or should have been discovered by timely exploration ahead of the Work shall rest solely with the Contractor.

Contractor'S RESPONSIBILITY FOR UTILITY PROPERTIES AND SERVICE

Where the Contractor's operation could cause damage or inconvenience to railway, telephone, fiber optic,

television, electrical power, oil, gas, water, sewer, irrigation system, or any other utility, the Contractor shall make all arrangements necessary for the protection of these utilities and services.

Notify all utility companies that are affected by the construction operation at least 48 hours in advance. Under no circumstance expose any utility without first obtaining permission from the appropriate agency. Once permission has been granted, locate, expose, and provide temporary support for all existing underground utilities and utility poles where necessary. Absolutely no extra compensation will be allowed for construction problems created by utility poles of whatever size, overhead electric, telephone or other lines, whether shown on the Plans or not. The Contractor is solely responsible for discerning such items in the field prior to bidding and including all costs for such work in the prices bid.

The Contractor and his Subcontractors shall be solely and directly responsible to the City and operators of such properties for any damage, injury, expense, loss, inconvenience, delay, suits, actions, or claims of any character brought because of any injuries or damage which may result from the construction operations under this Contract. Neither the City of Doral nor its officers or agents shall be responsible to the Contractor for damages as a result of the Contractor's failure to protect utilities encountered in the work.

In the event of interruption to domestic water, sewer, storm drain, or other utility services as a result of accidental breakage due to construction operations, promptly notify the proper authority. Cooperate with said authority in restoration of service as promptly as possible and bear all costs of repair. In no event shall interruption of any utility service be allowed unless granted by the City or the utility. In the event water service lines that interfere with trenching are encountered, the Contractor may, by obtaining prior approval of the water utility, cut the service, dig through, and restore the service with similar and equal materials at the Contractor's expense and as approved by the Engineer.

Contractor shall further replace, with material approved by the Engineer, at Contractor's expense, any and all other materials, existing utilities or structures removed or damaged during construction, unless otherwise provided for in these Contract Documents and as approved by the Engineer.

INTERFERING STRUCTURES

Take necessary precautions to prevent damage to existing structures whether on the surface, above ground, or underground. An attempt has been made to show major structures on the Drawings. While the information has been compiled from the best available sources, its completeness and accuracy cannot be guaranteed, and is presented as a guide. The Contractor is solely responsible for field verification of all locations and information provided and to determine the type, location, elevation and extent of any utilities which may not have been shown on the Plans.

FIELD RELOCATION

During the process of construction, it is expected that minor relocations of the work may be necessary. Such relocations shall be made only by the direction of the Engineer at the Contractor's expense. If existing structures are encountered that will prevent construction as shown, notify the Engineer before continuing with the work in order that the Engineer may make such field revisions as necessary to avoid conflict with the existing structures. If the Contractor fails to notify the Engineer when an existing structure is encountered, and proceeds with the work despite this interference, the Contractor does so at his own risk.

LAND FOR CONSTRUCTION PURPOSES

The Contractor shall limit his operations, temporary facilities and storage of equipment and materials to on-site

areas to be designated by the Engineer. No stringing of pipe is allowed along the pipe route except during the evening construction hours for the pipe to be installed that workday/night.

Should the Contractor require additional space he shall make his own arrangements for storage of materials and equipment in locations off the construction site. For the allocated space, submit to the Engineer for approval, proposed plan and layout for all temporary sanitary facilities, offices, storage facilities, temporary water service and distribution, and temporary power service and distribution. Prior to commencing any new construction remove, relocate and protect where necessary all existing underground and above ground facilities, pipelines, utility systems, plantings and all other existing installations. All of these existing features shall be restored to their initial or better than initial conditions.

ELEVATIONS AND LOCATIONS OF EXISTING INSTALLATIONS

The elevations and locations of existing installations, including piping, equipment, etc., shown on the Plans are approximate. Be responsible for verifying the accuracy of these locations and elevations prior to commencement of any work which is to be connected to the existing installation and immediately bring to the attention of the Engineer any and all discrepancies discovered.

The Contractor shall verify these locations and elevations sufficiently ahead of the Work to allow time for any necessary adjustments without delay to the progress of the installation. Costs due to delays occasioned by locations and/or elevations differing from those shown on the Plans which could have or should have been discovered by timely verification ahead of the Work shall rest solely with the Contractor. No request for additional compensation or Contract time (except for a non-compensable time extension at the sole discretion of the Engineer, whose decision shall be final) resulting from encountering interfering installations not shown, or existing installations differing in location or elevation from that shown, will be considered.

HURRICANE PREPAREDNESS

The Contractor shall submit a "Site Specific" Hurricane Preparedness Plan to the City and Engineer at the Pre-construction Conference. The Plan shall outline the necessary measures that the Contractor proposes to perform at no additional cost to the City in case of a hurricane watch and a hurricane warning.

During such periods of time as designated by the United States Weather Bureau or local authorities as being a hurricane alert, the Contractor shall perform all precautions as necessary to safeguard the work and property, including the removal of all small equipment and materials from the site, lashing all other equipment and materials to each other and to rigid construction, and any other safety measures as may be directed by the Engineer and the City.

Upon Notification of a Hurricane Watch, Contractor shall prepare and submit for approval a Plan of Action for the specific actions to be taken on this project.

Upon Notification of a Hurricane Warning, Contractor shall:

1. Implement the approved Plan of Action to protect the Project and the public; and
2. Backfill all open trenches, remove all construction equipment and materials from the right-of-way, remove unnecessary traffic barricades and signs, secure remaining barricades by "half burial" or "double sandbags".

**PROTECTION OF EXISTING FACILITIES, VEGETATION, STRUCTURES, UTILITIES, AND
IMPROVEMENTS**

The Contractor shall preserve and protect existing vegetation such as trees, shrubs, and grass on or adjacent to the work site which are not indicated to be removed and which do not unreasonably interfere with the construction work and he shall replace in kind the vegetation, shrubs and grass damaged by him at his own expense.

The Contractor shall protect from damage all utilities, foundations, walls or other parts of adjacent, abutting or overhead buildings, railroads, bridges, structures, surface and subsurface structures at or near the site of the Work and shall repair or restore any damage to such facilities, except utilities, resulting from failure to comply with the requirements of the Contract or the failure to exercise reasonable care in the performance of the Work. If, after receipt of notification from the Architect/Engineer, the Contractor fails to or refuses to repair any such damage promptly, the Owner may have the necessary Work performed and charge the cost thereof to the Contractor.

At points where the Contractor's operations are adjacent to utility facilities, damage to which might result in expense, loss, disruption of service or other undue inconvenience to the public or to Owners, Work shall not be commenced until all arrangements necessary for the protection thereof have been made by the Contractor. The Contractor shall be solely and directly responsible to the Owners and operators of such utilities for any damage, injury, expense, loss, inconvenience, or delay, caused by the Contractor's operations.

Where public utilities or their appurtenances interfere with permanent construction, unless otherwise specified, work involved in permanently relocating or otherwise altering such public utilities and their appurtenances will not be a part of this Contract but will be done by utility Owners at no cost to the Contractor. If the Contractor wishes to have utilities temporarily relocated, he shall make necessary arrangements with utility Owners and reimburse them at his own expense for cost of the Work. The Contractor shall keep the Architect/Engineer advised of temporary relocation arrangements.

The Contractor shall not repair or attempt to repair utility damage but shall immediately contact the utility Owner. The Contractor shall obtain the name, address and telephone number of each utility company that the work will affect and the person in such utility company to contact. He shall submit to the Architect/Engineer said names, addresses and telephone numbers.

The Contractor shall comply with the latest version of the Florida Building Code or the Code under which the Contract Documents were approved, whichever is applicable at the time of the Work is performed.

In order to safeguard the Owners and tenants of abutting property and at the same time prevent unjust or fraudulent claims against the Contractor the Government, State, the Owner and the Architect/Engineer in respect thereto, the Contractor shall cause a detailed examination of abutting property to be made before construction is begun. The Owner or tenant of each parcel or structure or his or their duly authorized representative will be invited to be present during the examination by a notice in writing delivered by the Contractor to a person in charge of the premises or structures, or by the mailing of the notice to the Owner at the premises. The Architect/Engineer will attend while the Contractor makes the detailed examination. A complete record including photographs of the existing conditions of each parcel or structure shall be made in triplicate, signed by the Contractor, Owner and the Architect/Engineer and one copy will be delivered to the Owner, one to the Architect/Engineer and one copy will be retained by the Contractor. At such time as the Architect/Engineer may direct, or upon the filing of the verified statement by the Owner, tenant, lessee, operator or occupant of the

Exhibit D – Additional Specifications

building structure, and in any event, upon the completion of any work that in the opinion on the Architect/Engineer might affect the abutting property, the Contractor will make another detailed examination of such abutting property. A complete record of the then existing conditions of said property will be made in triplicate, signed by the Contractor and one copy will be delivered to the Owner, one to the Architect/Engineer and one will be retained by the Contractor. In any action, which may be brought by any Owner, tenant, lessee, operator or occupant of abutting property to recover under the provisions of this article or any paragraph hereof, the record of the existing conditions of each parcel will be prima facie evidence of the conditions thereof at the time of the making of the examination.

The Contractor shall maintain access to fire hydrants and fire alarm boxes throughout the prosecution of the Work. Hydrants, alarm boxes and standpipe connections shall be kept clear and visible at all times unless approved otherwise. If visibility cannot be maintained, the Contractor shall provide clearly visible signs showing the location of the fire hydrant, fire alarm box or standpipe connection. The Contractor shall promptly notify the authority having jurisdiction of any impairment to any fire systems.

INTERFERENCE WITH EXISTING UTILITIES

Attention of the Contractor is specifically directed to the need for careful control of all aspect of his work to prevent damage to cables, ducts, water mains, sewers, fire mains, telephone cables, fuel lines, radar cables, and any other existing overhead or underground utilities and structures.

Before commencing work in any given area, the Contractor shall contact utility companies to identify any potential conflicts. Further, the Contractor shall also carefully review the Plans, survey and search the site for utility locations, and determine possible utility conflicts. All known above and underground utilities, including, but not limited to , electrical, telephone, communications, lighting cables, fuel lines, sewer, drainage and water pipes, and other existing structures are shown on the Plans for reference purposes only, but no guarantee is expressed or implied that the information is accurate. It shall be the sole responsibility of the Contractor to ascertain and/or verify the location of any and all such utilities or structures using magnetic and electronic detector and by hand excavation or other appropriate measures before performing any work that could result in damage to such existing utilities or structures. The Contractor shall make a thorough search of the particular location for underground utilities or structures whether or not shown on the drawings, before excavation work is commenced in any particular location. To this end of the Contractor shall provide and maintain throughout the term of the Contract, electronic and magnetic detecting devices capable of locating underground utilities or structures. The Contractor shall, after locating primary and critical existing utilities, mark their location with indelible material or other means satisfactory to the Field Representative and maintain above ground physical identification during the work.

In the event of damage to, or accidental disruption of utilities or other facilities as a result of the Contractor's operations, the Contractor shall take immediate steps to repair or replace all damage and to restore all services. Further, the Contractor shall engage any additional outside services which may be necessary to prosecute repairs on a continuous "around the clock" basis until services are restored. The Contractor shall also provide and operate any supplemental temporary services to maintain uninterrupted use of the facilities. All costs involved in making repairs and restoring disrupted service resulting from the Contractor's work shall be borne by the Contractor and the Contractor shall be fully responsible for any and all claims resulting from the damage.

ENVIRONMENTAL PROTECTION AND SPECIAL CONTROLS

PART 900 - GENERAL

900.1 SUMMARY

A. Section Includes:

1. Minimizing the pollution of air, water, or land; control of noise, the disposal of solid waste materials, and protection of deposits of historical or archaeological interest.

B. Related Specification Sections include but are not necessarily limited to:

1. Division 00 - Front Ends Documents.
2. Division 01 - General Requirements.

900.2 SUBMITTALS

A. Shop Drawings:

1. See Specification Section 01340 for requirements for the mechanics and administration of the submittal process.
2. Prior to the start of any construction activities submit:
 - a. A detailed proposal of all methods of control and preventive measures to be utilized for environmental protection.
 - b. A drawing of the work area, haul routes, storage areas, access routes and current land conditions including trees and vegetation.
 - c. A copy of the NPDES permit for storm water discharges from construction activities.
 - d. A copy of the approved pollution prevention plan.

900.3 - PRODUCTS – (NOT APPLICABLE TO THIS SPECIFICATION SECTION)

900.4 - EXECUTION

900.4.1 INSTALLATION

A. Employ and utilize environmental protection methods, obtain all necessary permits, and fully observe all local, state, and federal regulations.

B. Land Protection:

1. Except for any work or storage area and access routes specifically assigned for the use of the Contractor, the land areas outside the limits of construction shall be preserved in their present condition.
 - a. Contractor shall confine his construction activities to areas defined for work within the Contract Documents.
2. Manage and control all borrow areas, work or storage areas, access routes and embankments to prevent sediment from entering nearby water or land adjacent to the work site.
3. Restore all disturbed areas including borrow and haul areas and establish a permanent type of locally adaptable vegetative cover.
4. Unless earthwork is immediately paved or surfaced, protect all side slopes and backslopes immediately upon completion of final grading.
5. Plan and execute earthwork in a manner to minimize duration of exposure of unprotected soils.

6. Except for areas designated by the Contract Documents to be cleared and grubbed, the Contractor shall not deface, injure or destroy trees and vegetation, nor remove, cut, or disturb them without approval of the Engineer.

a. Any damage caused by the Contractor's equipment or operations shall be restored as nearly as possible to its original condition at the Contractor's expense.

C. Surface Water Protection:

1. Utilize, as necessary, erosion control methods to protect side and backslopes, minimize and the discharge of sediment to the surface water leaving the construction site as soon as rough grading is complete.

a. These controls shall be maintained until the site is ready for final grading and landscaping or until they are no longer warranted, and concurrence is received from the Engineer.

b. Physically retard the rate and volume of run-on and runoff by:

1) Implementing structural practices such as diversion swales, terraces, straw bales, silt fences, berms, storm drain inlet protection, rocked outlet protection, sediment traps and temporary basins.

2) Implementing vegetative practices such as temporary seeding, permanent seeding, mulching, sod stabilization, vegetative buffers, hydroseeding, anchored erosion control blankets, sodding, vegetated swales or a combination of these methods.

3) Providing Construction sites with graveled or rocked access entrance and exit drives and parking areas to reduce the tracking of sediment onto public or private roads.

2. Discharges from the construction site shall not contain pollutants at concentrations that produce objectionable films, colors, turbidity, deposits or noxious odors in the receiving stream or waterway.

D. Solid Waste Disposal:

1. Collect solid waste on a daily basis.

2. Provide disposal of degradable solid waste to an approved solid waste disposal site.

3. Provide disposal of nondegradable solid waste to an approved solid waste disposal site or in an alternate manner approved by Engineer and regulatory agencies.

4. No building materials wastes, or unused building materials shall be buried, dumped, or disposed of on the site.

E. Fuel and Chemical Handling:

1. Store and dispose of chemical wastes in a manner approved by regulatory agencies.

2. Take special measures to prevent chemicals, fuels, oils, greases, herbicides, and insecticides from entering drainage ways.

3. Do not allow water used in onsite material processing, concrete curing, cleanup, and other waste waters to enter a drainage way(s) or stream.

4. The Contractor shall provide containment around fueling and chemical storage areas to ensure that spills in these areas do not reach waters of the state.

F. Control of Dust:

1. The control of dust shall mean that no construction activity shall take place without applying all such reasonable measures as may be required to prevent particulate matter from becoming airborne so that it remains visible beyond the limits of construction.

a. Reasonable measures may include paving, frequent road cleaning, planting vegetative groundcover, application of water or application of chemical dust suppressants.

b. The use of chemical agents such as calcium chloride must be approved by the State of Florida DOT.

2. Utilize methods and practices of construction to eliminate dust in full observance of agency regulations.

3. The Engineer will determine the effectiveness of the dust control program and may request the Contractor to

provide additional measures, at no additional cost to Owner.

G. Burning:

1. Do not burn material on the site.
2. If the Contractor elects to dispose of waste materials by burning, decide for an off-site burning area and conform to all agency regulations.

H. Control of Noise:

1. Control noise by fitting equipment with appropriate mufflers.

I. Completion of Work:

1. Upon completion of work, leave area in a clean, natural looking condition.
2. Ensure all signs of temporary construction and activities incidental to construction of required permanent work are removed.

J. Historical Protection:

1. If during the course of construction, evidence of deposits of historical or archaeological interests is found, cease work affecting find and notify Engineer.
 - a. Do not disturb deposits until written notice from Engineer is given to proceed.
2. The Contractor will be compensated for lost time or changes in construction to avoid the find based upon normal change order procedures.

CONTAMINATED SOIL/GROUNDWATER

PART 1 - GENERAL

The purpose of this section is to provide basic guidelines for properly working (i.e., excavation, handling, transportation, disposal, etc.) with contaminated soil/groundwater during construction and/or any other activities that require the excavation of soil and/or exposure of groundwater, to prevent negative environmental impacts such as cross contamination, spreading out existing contamination that is already contained, etc. All excavation shall be conducted in accordance with the contract and construction documents. The contractors and all subcontractors shall comply with all applicable federal, state and local environmental laws and regulations including but not limited to US Environmental Protection Agency (EPA), Florida Department of Environmental Protection (FDEP), South Florida Water Management District (SFWMD) and Miami-Dade County Department of Environmental Resources Management (DERM).

PART 2 - CLASSIFICATIONS

For the purpose of these specifications the following classifications are used:

1. Clean Fill Soils: These soils meet the DERM defined clean fill criteria and can be reused anywhere without restrictions.
2. Residential Soils: These soils meet the DERM defined residential criteria and upon DERM approval can be reused on site without tracking requirements.
3. Industrial Soils: These soils meet the DERM defined industrial criteria and upon DERM approval can be reused. These soils require tracking from origin to final disposition.
4. Environmentally Non-Reusable Soils (ENR): These soils exceed the DERM defined industrial or the Federal hazardous levels and cannot be reused on site. These soils require proper disposal offsite.
5. Suspect Soils: Soils from any area pre-designated by DERM as an area where the requirements of this Standard Technical Specification shall be implemented, pursuant to the results of the pre-construction assessment or designated during field activities by City of Doral/Miami Dade County or its designated representatives.

PART 3 HEALTH AND SAFETY

The contractors and all subcontractors working with contaminated soil/groundwater shall conform to all applicable laws, regulations, and guidelines such as, but not limited to, EPA Hazardous Waste Operations and Emergency Response (HAZWOPER), US Occupational Safety and Health Agency (OSHA) and National Institute of Occupational Safety and Health (NIOSH).

PART 4 CONSTRUCTION METHODS

CONTAMINATED SOIL/ GROUNDWATER DETECTION

If contaminated groundwater, visible stains in the soil, free floating product, sheen on groundwater, or odor in soil/groundwater are detected during the normal course of construction activities, the Contractor shall immediately:

1. Notify the Architect/Engineer (A/E).
2. Notify the City of Doral
3. Notify DERM at (305) 372-6789.
4. Proceed with the work in accordance to the contract and construction documents and the provisions of these guidelines. To avoid miscommunication, any directives from City of Doral and/or DERM shall be given through the A/E to the Contractor.

STOCKPILING OF SUSPECTED AND ENR SOIL

Prior to the excavation of suspected and ENR soil, the Contractor shall prepare a suitable area previously approved by the A/E Firm for stockpiling such soil in accordance with the contract and construction documents. The Contractor shall take due care during the stockpiling operation to prevent the spread of any further contamination. The stockpile shall not exceed twelve (12) feet in height. The Contractor shall regularly inspect the stockpile area and restore its protection membranes to their original required condition and maintain them throughout the entire construction contract period.

After the Contractor has safely completed the stockpiling, (A/E Firm) shall collect soil samples (by volume) from the stockpile and send the samples to a laboratory certified by Miami Dade County and the State of Florida to be analyzed for applicable environmental criteria. Once a stockpile has been sampled, it cannot be altered in any way. Therefore, the (A/E Firm) shall mark the stockpile with a yellow flag, indicating that the final disposition of the stockpile is pending the analytical results from the laboratory. Once the analytical results are available, DERM shall determine the final disposition of the soil. If according to the analytical results, DERM determines that the soil can be reused on site, (A/E Firm) shall remove the yellow flag and replace it with a green flag, indicating that the stockpile has been approved for reuse on site. If according to the analytical results, DERM determines that the soil cannot be reused and therefore it must be properly disposed of, (A/E Firm) shall remove the yellow flag and replace it with a red flag, indicating that the stockpile cannot be reused. Unless otherwise specified by the (A/E Firm), the Contractor shall handle, transport and properly dispose of all ENR soils.

Prior to the excavation of suspected soil, the Contractor shall prepare a suitable area (previously approved by the A/E) for stockpiling soil on an impervious surface, away from any drainage and/or active utility structures. If an impervious surface is not available, the Contractor shall create it by laying down two (2) layers of polyethylene film (each a minimum of four (4) mils thick) on a flat horizontal surface with a twelve (12) inch high berm around its perimeter. The stockpile area shall be free of any sharp materials and debris that could accidentally puncture the polyethylene film. The area selected for stockpiling must be free from water ponding. Once the stockpile is completed, a single layer of the same polyethylene film material shall be placed over the stockpile and secured properly. Rainwater must be directed outside the berm-contained area. Any rainwater collected inside the berm-contained area, must be collected, stored and treated as directed by the A/E. Continued inspection of the stockpile area is required to ensure the polyethylene film is intact and secure and to maintain proper drainage and drainage collection as stated herein.

TRANSPORTATION/ HAULING OF SOIL

The Contractor shall transport the ENR soil in accordance with all applicable laws and regulations. Haulers shall be certified to transport the soil as classified.

DISPOSAL OF NON-HAZARDOUS SOIL AT LANDFILL

If the soil is to be disposed of in a landfill, the Contractor shall dispose of all non-hazardous soils in an approved landfill licensed to handle the soil as classified. The Contractor shall conduct disposal activities in accordance with all applicable laws and regulations.

INCINERATION OF SOIL

If the soil is to be incinerated, the Contractor shall transport the soil to a certified incineration facility licensed to handle the soil as classified. The Contractor shall conduct the transportation and handling activities in accordance with all applicable laws and regulations.

DISPOSAL OF HAZARDOUS SOIL

If soil is classified as hazardous, the Contractor shall prepare, transport and dispose of the soil in accordance with all applicable laws and regulations such as, but not limited to, the Code of Federal Regulations (CFR), EPA, FDEP, DERM, etc., at a licensed hazardous material disposal facility.

REMOVAL/DISPOSAL OF FREE-FLOATING HYDROCARBON PRODUCT (FFHP)

Contractor shall remove/dispose of FFHP and/or sheen in accordance with all applicable laws and regulations.

TRANSPORTATION/DISPOSAL MANIFESTS

The Contractor shall provide copies of all the manifests for the proper transportation/disposal of contaminated soil and/or free-floating product to the A/E and the City of Doral.

DEWATERING/TREATMENT OF CONTAMINATED DEWATERING GROUNDWATER

City of Doral encourages, whenever possible, that construction activities be carried out in the wet. If dewatering in areas of groundwater contamination is absolutely necessary for construction purposes, the Contractor shall apply for and obtain the dewatering permit(s) from the appropriate regulatory agencies. Once the permit(s) has(have) been obtained, the Contractor shall comply with all the permit conditions during the entire course of the dewatering activities. If the permit(s) expire(s) before the dewatering activities are completed, the Contractor shall obtain a permit renewal within the stipulated time frame. The Monthly Pumpage Report required by the dewatering permit shall be submitted to the City of Doral no later than the 5th day of the following month.

SUBMITTALS

Contractor shall submit information and samples to the City for review as follows. The information shall include:

1. Detailed description of the proposed methods for temporary stockpiling, transportation, and disposal of all contaminated soils and groundwater.
2. Copies of permits for all disposal facilities.
3. Copies of all manifest and documentation for handling and disposing of all contaminated soil and groundwater in full compliance with local, state and federal requirements. This documentation must be provided prior to requesting payment under this Bid item.
4. Copies of all laboratory analyses required for transportation and disposal of all contaminated soils and groundwater in full compliance with local, state and federal requirements.
5. Names, addresses and contact numbers of all subcontractors.
6. Copy of Contractor's Health and Safety Plan and training certificates of personnel who will be handling the contaminated material in accordance with OSHA requirements.

PART 5 MEASUREMENT AND PAYMENT

Dedicated Allowance shall be as determined by the City's Architecture and Engineering firm.

CLEARING AND GRUBBING / LANDSCAPING / SITE CLEANLINESS

PART 1 GENERAL

1.01 WORK INCLUDED

A. Clear and grub the areas to be occupied by the facilities or utility systems to be constructed, including all areas to be excavated, filled, paved or planted as shown on the Plans and as specified herein.

1.02 DEFINITIONS

A. Clearing shall consist of the cutting, removal and disposal of all trees, stumps, brush, shrubs, rubbish and any other objectionable material within the designated areas.

B. Grubbing shall consist of the removal and disposal of all stumps larger than 1-1/2 inches in diameter and other objectionable material to a depth of at least 12 inches below the ground surface.

1.03 QUALITY ASSURANCE

A. In the course of the work, it may become necessary to remove trees if they interfere with the work. City of Doral and various municipalities have ordinances regulating the removal, relocation and pruning of trees in the public right-of-way; these ordinances shall be strictly adhered to. The Contractor shall obtain a permit from City of Doral, Miami-Dade County, Public Works and Waste Management County and/or other regulatory agencies having jurisdiction over the work area before removing, relocating and/or pruning any tree. The Contractor shall comply with all requirements and conditions of the permit at no additional cost to the City of Doral.

PART 2 PRODUCTS

NOT USED

PART 3 EXECUTION

3.01 CLEARING AND GRUBBING

A. The Contractor shall remove and replace, where required all existing shrubbery, trees, grass, sprinklers, fences, signs, mailboxes, structures, roadways, sidewalks, curbs and similar items or structures in the way of all excavation necessary for the construction of the Project.

3.02 PROTECTION OF ADJACENT AREAS

A. The Contractor shall protect areas shown on the Plans or designated by the Engineer to remain protected from damage by construction operations by erecting suitable barriers or other acceptable means.

3.03 DISPOSAL OF WASTE MATERIALS

A. All roots, vegetation and other refuse removed from the site during clearing and/or grubbing operations shall be legally disposed of by the Contractor. Burning of any material on site will not be permitted.

B. The Contractor shall provide the Engineer tickets indicating proof of legal disposal of unsuitable backfill material. If the unsuitable material has beneficial use, the transport destination needs to be reported to the Engineer. Payment for disposal of the unsuitable material shall not be made until the City of Doral has proof of legal disposal at a particular destination.

3.04 LANDSCAPING

A. General: Existing plants, trees and grassed areas damaged or destroyed by the Contractor's operations shall be restored or replaced by the Contractor, at his expense to equal or better than original condition, and to the satisfaction of the Engineer.

B. Solid Sod:

1. Solid sod shall be planted in the unpaved areas abutting the structures and extending to the limits shown on the Drawings.

2. When solid sod is to be placed adjacent to or in close proximity to existing sod or grass, the Contractor is to use similar sod or grass and obtain approval from the Engineer prior to installation. In public areas and rights-of-way the Contractor is also required to comply with Governmental Agency requirements and provide the City with written approval of said agency prior to installation of grass and sod.

3. All areas to be grass sodded shall first be leveled, and debris, rocks, and other undesirable matter removed. Topsoil shall then be placed to a minimum depth of 3", with all larger lumps broken up. The mixture shall be well worked and raked to a uniform surface and then hand tamped, or lightly rolled. The topsoil shall be moistened with water prior to placing sod.

4. The sod shall be placed with closely abutting joints and shall completely cover the disturbed areas. The top of the new sod shall coincide with the top of the existing grass. The sod shall be covered with a light top dressing of topsoil and shall then be thoroughly watered.

5. The Contractor shall weed and water the grassed areas until the Project is accepted by the City; however, the minimum period of this maintenance shall not be less than 60 days even if it extends beyond said acceptance. Any portions of the grassed areas which die or appear to have succumbed to the shock of transplanting, before the acceptance by the City, or expiration of the minimum 60-day maintenance period, shall be replaced by the Contractor at his expense.

6. Solid sod shall be certified bitter blue St. Augustine Floratam. The sod shall be firm touch texture having a compact growth of grass with good root development. It shall contain no weeds or other objectionable vegetation.

7. Where sodding is used in drainage ditches, the setting of the pieces shall be staggered to avoid a continuous seam along the line of flow. Along the edges of such staggered areas, the offsets of individual strips shall not exceed 6-inches. In order to prevent erosion caused by vertical edges at the outer limits, the outer pieces of sod shall be tamped to produce a featheredge effect.

8. Sodding shall not be performed when weather and soil conditions are, in the Engineer of Record's

opinion, unsuitable for proper results.

C. Watering:

The areas on which the sod is to be placed shall contain sufficient moisture, as determined by the Engineer, for optimum results. After being placed, the sod shall be kept in a moist condition to the full depth of the rooting zone for at least 2 weeks. Thereafter, the Contractor shall apply water as needed until the sod roots and starts to grow for a minimum of 60 days (or until final acceptance whichever is latest).

3.05 SITE CLEANLINESS

A. The Contractor shall at all times during the execution of this Contract keep the work site free and clear of all rubbish and debris. As soon as the work is completed, the accumulated rubbish or surplus materials shall be promptly removed. The Contractor shall also restore in an acceptable manner all property, both public and private, which has been displaced or damaged during the prosecution of the work and shall leave the site and vicinity unobstructed and in a neat and presentable condition.

B. In the event of delay exceeding two days after written notice is given to the Contractor by the Engineer to remove such rubbish or materials or to restore displaced or damaged property, the Engineer may employ such labor and equipment as he may deem necessary for the purpose, and the cost of such work, together with the cost of supervision, shall be charged to the Contractor and shall be deducted from any monies due him. The Project shall not be considered as having been completed until all rubbish and surplus materials have been removed.

CONCRETE DRIVEWAY, SIDEWALK, AND CURB AND GUTTER REMOVAL AND REPLACEMENT

Work covered under this Section covers the furnishing of all labor, equipment and material required for cutting, removing, protecting and replacing all existing concrete driveways, sidewalks, and curb and gutter of the various types encountered, removed or damaged under this Contract.

General Requirements

A. Contractor shall be responsible for the protection from damage from his construction operations, all concrete driveways, sidewalk, and curb and gutter within the work area. If payment items are established in the Proposal for the removal and replacement of concrete driveway, sidewalk, and curb and gutter, payment will be made only if such items are encountered within the limits of the trench width plus 2 feet (shoulders) An concrete driveway, sidewalk, or curb and gutter beyond those limits, damaged as a result of the Contractor's operation, shall be restored in accordance with the applicable requirements of these Specifications, and to the satisfaction of the Engineer, at no additional cost to the City. In order to protect himself from being held liable for any existing damaged concrete driveways, sidewalks or curb and gutter, the Contractor is advised to notify in writing the authority having jurisdiction over the street where such damage exists prior to proceeding with any work in the vicinity. A copy of all such notices shall be forwarded to the Engineer.

B. No payment will be made for removal and replacement of concrete driveway, sidewalk, or curb and gutter which falls outside the above-described limits required for thrust blocks, and other appurtenant items, and the cost for such work shall be included in the price bid for the applicable item.

C. If payment items have not been established in the Proposal for the removal and replacement of concrete driveways, sidewalks, and curb and gutter, the cost for such work shall be included in the overall Project cost bid. No other compensation will be provided.

D. No form shall be set higher than the elevation of the adjacent concrete surface.

E. As used herein, "driveway" shall mean concrete driveway, and "curb and gutter" shall mean free standing curb, gutter, or combination curb and gutter.

F. All concrete shall be treated with a liquid curing compound, and in some cases, concrete colorant shall be required in order to match the color of the existing concrete being replaced. In each such case the curing compound, the colorant, and the color, shall meet with the approval of the Engineer and the municipality having jurisdiction over the work area. All additives to the concrete shall be applied in strict conformance with the recommendations of the manufacturer.

G. The Contractor shall provide adequate means to protect each driveway, sidewalk, and curb and gutter installation from damage from vandals, animals, weather or other causes, until the concrete is hard. Should damage occur from such causes, the Contractor shall remove and replace the damaged item at his own expense.

Concrete Driveways

A. Concrete driveways, and sidewalks crossing driveways, shall be restored in full sections or blocks rather than trench width plus two feet (shoulders), if the original construction was divided into such sections or blocks. The existing driveway (or sidewalk) shall be cut with an abrasive disc saw to trim the edges to straight and true

lines, with edges parallel and rectangular in plan. The interior concrete shall then be broken up and removed from the site.

B. Driveways, and sidewalks crossing driveways, shall be replaced with a concrete slab having a minimum thickness of 6 inches. Steel reinforcement is not required unless the existing driveway (or sidewalk) is so reinforced, in which case the replaced driveway shall also be reinforced to match the existing.

C. Such forms as are necessary shall be set up and the subgrade regarded for a slab 6 inches thick. The subgrade shall be thoroughly compacted and wet down prior to placing the concrete. The surface shall be given a surface and edging to match, as nearly as possible, that of the existing driveway (or sidewalk). The finish and edging shall be obtained through the use of screeds, trowels, edges and any other tool normally required by the trade in performing this kind of work.

D. All forms for driveways (or sidewalks) including those for expansion joints, shall be metal and shall be clean and well-oiled prior to placing concrete. The forms shall be set in place far enough in advance of concrete placing for the Engineer to check line and grade. Abrupt changes in line and grade will not be permitted, and forms shall be set to insure smooth curvature and alignment both vertically and horizontally. Forms shall be left in place for a minimum of 24 hours after concrete has been placed.

E. Replacement driveways (and sidewalks) shall match the elevation and alignment of existing driveways (and sidewalk) wherever a connection is made.

Sidewalks

A. Sidewalks shall be restored in full section rather than trench width plus 2 feet (shoulder).

B. Removal of existing sidewalk, installation of forms, preparation of subgrade, and the final finish shall be performed as specified hereinabove for driveways, except that the minimum thickness of the sidewalk shall be 4 inches thick.

Curb and Gutter

A. Curb and gutter shall be restored in lengths equal to trench width plus 2 feet (shoulders), or 10 feet, whichever is greater, unless otherwise permitted or ordered by the Engineer.

EXCAVATION / TRENCH STABILIZATION / TRENCH OVERCUT / COMPACTED BACKFILL

910.1 EXCAVATION

- A. The Contractor shall remove and replace, where required, all existing shrubbery, trees, grass, sprinklers, fences, signs, mail boxes, structures, roadways, sidewalks, curbs and similar items or structures in the way of the pipeline and shall make all excavation necessary for the construction of the connections to the lines and grades shown on the Drawings. Weeded areas shall be restored to their original condition in an acceptable manner. Where pavements or sidewalks are cut, they shall be cut by means of a mechanical pavement saw to form true and straight edges which shall in general be either parallel or at right angles with the centerline of the pipe. Unless specific bid items are provided in the Proposal form, the cost of removing and replacing any plantings or existing structures shall be included in the price bid for pipes, structures, and concrete appurtenances. In order to protect Contractor from being held liable for any existing damaged pavement, including detour routes, the Contractor is advised to notify in writing the authority having jurisdiction over the street where such defective pavement exists prior to proceeding with any work in the vicinity. A copy of all such notices shall be forwarded to the Engineer.
- B. All cleared materials shall be promptly removed from the work area and disposed of in an area provided by the Contractor, at no additional cost to City. Accumulation of debris or stockpiling along the route of the work will not be allowed.
- C. The Contractor shall excavate solid pipe trenches to a minimum of six inches below the outside bottom of the proposed pipe barrel to provide for the installation of the bedding material or as dictated by design drawings; whichever is more stringent.
- D. Not more than 100 feet of trench shall be opened ahead of pipe laying operations at one time unless a greater length of open trench is approved by the Engineer.
- E. If, in the opinion of the Engineer, the soil at that depth is unsatisfactory as foundation material because it contains marl, muck, organic matter, or other unsuitable material, the excavation shall be continued two (2) feet deeper, except if a suitable foundation material is exposed at a lesser depth, further excavation will not be required. The cost of this extra excavation, and backfilling with select backfill material, shall be included in the price for pipe laying and no additional payment will be made for this work.
- F. If the soil is still unsuitable after the additional excavation as prescribed above, and the Engineer authorizes "Overcut", the trench bottom shall be excavated further in one-foot increments and paid for as "Trench Overcut". See Section 910.3, "Trench Overcut".
- G. Trench widths; Refer to Plans provided and as details shown.
- H. For excavations five (5) feet deep or less, sheeting and shoring shall be installed where necessary to control trench width, protect the workmen and the general public, and prevent damage to this or adjacent work, or structures. When an excavation is in excess of five (5) feet deep, the Contractor shall comply with the provisions of the State of Florida "Trench Safety Act". Method(s) of compliance used shall protect the workmen and the general public, prevent damage to this or adjacent work, structures, utilities, pavements, sidewalks, curbs, gutters and similar improvements both public and private, and provide for proper maintenance of traffic. The trench width may vary to accomplish this and to comply with the Trench Safety Act, but only from a point

one (1) foot above the top of the pipe.

I. Where wood sheeting or certain designs of steel sheeting are used, the City may require that the sheeting be cut off at a level two (2) feet above the top of the installed pipe and that portion below that level be left in place. If ordered left in place, sheeting and shoring shall be paid for under the appropriate Proposal Item.

J. If interlocking steel sheeting is used, the City may permit its complete removal in lieu of the cut-off, providing removal can be accomplished without disturbing the bedding, pipe or pipe alignment. Any damage to the pipe bedding, pipe or pipe alignment shall be cause for rejection of the affected portion of the work.

K. A substantially and safely constructed moveable shield or box, as approved by the Engineer, may be used in place of sheeting when the trench is opened immediately behind the shield as pipe laying proceeds inside the shield. All construction in conjunction with using such a shield must be as approved by the Engineer, including excavation, installation of pipe and backfilling and compaction.

L. Excavation for other piping and appurtenances shall be sufficient to leave at least 12 inches clear between their outer surfaces and the embankment or sheeting that may be used to protect them.

M. Materials removed from the trenches shall be stored and disposed of in such a manner that they will not interfere unduly with traffic on public streets and sidewalks and they shall not be placed on private property. In congested areas, such materials cannot be stored adjacent to the trench or used immediately as backfill; these materials shall be removed to convenient places of storage. If any material is creating a public hazard or other unsafe condition, in the opinion of the Engineer, it shall be removed immediately by the Contractor to a storage area at no cost to the City.

N. The trench wall shall be kept at a stable angle of repose to maintain trench widths within the limits hereinafter specified or shown on the Drawings.

O. The trench, when in rock, shall be excavated to a width within the limits of the top of the pipe and the trench bottom so as to provide a clearance on each side of the pipe barrel, measured to the face of the excavation, of 12 inches. Rock or removal in the excavation shall be considered a part of the excavation and as such no additional payment shall be made, therefore. Where excavation is in silt, the width of trench bottom shall be pipe O.D. plus 2- feet with the trench walls being kept at a stable angle of repose. All pipe trenches shall be excavated to a level at least 12 inches below the outside bottom of the proposed pipe barrel.

P. The Contractor shall perform all excavation of every description and of whatever substances encountered, to the dimensions and depth shown on the Drawings, or as directed by the Engineer. All excavations shall be made by open cut. Any existing utilities such as pipes, cables, etc., shall be carefully supported and protected from damage, and in case of damage, they shall be restored at no cost to the City.

Q. The Contractor shall temporarily store excavated material suitable for backfill in full compliance with the provisions of the permits. All mud, silt, debris and other material unsuitable for backfilling the trench shall be removed and legally disposed of offsite by the Contractor. The Contractor shall make his own arrangements regarding stock piling of excavated suitable material and storage and assembly space to properly and safely carry out the construction. Any agreements entered into by the Contractor and property Owners shall hold the City harmless. Storage of excavated material shall not cause environmental problems and shall be performed at no additional cost to the City.

910.2 TRENCH STABILIZATION

A. No claim for extras or additional payment will be considered for cost incurred in the stabilization of trench bottoms which are rendered soft or unstable as a result of construction methods, such as improper or inadequate sheeting, dewatering or other causes. In no event shall pipe be installed when such conditions exist, and the Contractor shall correct such conditions to provide proper bedding or foundations for the proposed installation at no additional cost to the City.

910.3 TRENCH OVERCUT

A. Trench Overcut provisions herein shall be used only under direct authorization by the Engineer. Since the amount of trench overcut that may be required is usually unknown until the actual work begins, trench overcut may be established in the Proposal on a contingent basis. A Contingent Item may or may not be used at the option of the City, and any provisions contained within the Contract Documents for quantity overruns or underruns will not be applicable.

B. If, after excavating the trench to a depth of 2 feet 6 inches below the outside bottom elevation of the proposed pipe barrel, and the soil at that depth is still unsatisfactory as foundation material because it contains marl, muck, organic matter, or other unsuitable material, and the Engineer authorizes overcut, the pipe trench shall be excavated further in one-foot increments until either a suitable foundation material is found, or the Contractor is directed by the Engineer to stop trench overcut operation and begin backfilling. In no case will trench overcut be more than 6 feet in depth, i.e., to a point 8.5 feet below the bottom of the pipe.

B. Selected backfill, as defined in Section 910.4, "Compacted Backfill", shall then be compacted in 6-inch layers up to the bottom of the proposed 6 inches of pipe bedding.

910.4 COMPACTED BACKFILL

A. When mains are to be installed within existing street areas, the Contractor shall limit the amount of ditch open at any one time to one block (approximately 600 feet). The work in each block including excavation, pipe laying, backfilling, compaction and temporary paving, shall be completed before proceeding with the work in the next block. The Contractor may employ more than one installation crew on the Project, but not less than 1,200 feet shall separate any two open trench sections.

B. Backfilling and compaction shall be kept up with the rate of pipe laying. Backfill consisting of the specified material shall be placed and properly compacted, to the degree specified hereinafter. Unless otherwise ordered or approved by the Engineer, in writing, no temporary fill, refill, or uncompacted fill shall be installed. Under no circumstances shall backfill material other than that specified or an approved equal be installed. Backfill shall be placed and compacted immediately after installation of piping.

C. Backfill Material: Shall be clean and free from all organic material, clay, marl or unstable materials, debris, lumps or broken paving. No rocks or stones larger than 6 inches in diameter shall be allowed in any backfill. Material for backfill may be material resulting from trench excavation, if suitable in the opinion of the Engineer.

D. Select Backfill Material: Specified in these Specifications or required by the Drawings shall meet all of the general requirements for backfill material set forth above, and, in addition, shall be free of any rocks or stones larger than 2 inches in diameter. Select backfill material may be material resulting from trench excavation, if suitable in the opinion of the Engineer, carefully selected to comply with these requirements.

E. Backfilling and compaction of trenches will not be allowed until the work has been inspected by the Engineer, and the Engineer indicates that backfilling and compaction may proceed. Any work covered up or concealed without the knowledge or consent of the Engineer may be required to be uncovered or exposed at no cost to the Department.

F. The Contractor shall backfill and compact all trenches and other excavations made in the process of installing the pipe. The cost of all backfilling and compaction shall be included in the price bid under the various Items. The Contractor shall maintain the surface of the backfill free from major irregularities and potholes. Backfill to a point at least one foot above the pipe shall be select backfill material not exceeding 2 inches in diameter. Above this point, backfill shall be of material not exceeding 6 inches in diameter.

G. Backfilling and compacting of material under and around the pipe and to one foot above the crown shall be in layers not exceeding 6 inches in thickness. Each layer shall be thoroughly compacted to at least 90 percent of maximum density as determined by AASHTO Standard No T-180-74, "Moisture-Density Relations of Soils using a 10-lb. (4.54 Kg.) Rammer and an 18 in. (457 mm) Drop." The material in the ditch may be compacted by either hand tamper or a mechanized power tamper, provided the results obtained meet the continued approval of the Engineer.

H. Backfilling and compacting of material lying above a point one foot above the crown of the pipe and below the pavement base or the surface of the ground if out of pavement shall be accomplished in layers not exceeding 9 inches in thickness. Each layer shall be thoroughly compacted with a powered hand tamper or a mechanized power tamper to at least 98 percent of maximum density as determined by AASHTO Specification T-180-74 or such greater density as may be required by the governing authority over the area in which the work is performed.

I. Backfill and compaction shall be kept up with the rate of pipe laying. The backfill up to the spring line of the pipe shall be placed and compacted as soon as practical after the laying of the pipe.

J. On parts of the line where ground water level may be high enough to float the pipe, the placing of the backfill and the rate of pumping the trench shall be so controlled as to prevent the pipe from floating or moving from the line and grade shown on the Drawings.

K. In the event that sufficient suitable material is not available at any point to properly backfill the trench, the Contractor shall transport suitable material from points of the line where such material is available or shall otherwise furnish suitable material at no additional cost to the City.

L. Suitable material in excess of all backfill requirements shall be removed from the work and disposed of by the Contractor. The cost for removal shall be included in the overall Project cost bid.

M. Where cuts have been made through unpaved, stabilized rock roadways, driveways and parkways, surface restoration shall consist of 3 inches of compacted lime rock overlaid by 3 inches of gravel or graded and washed rock with a maximum diameter of 1/2-inch except as otherwise directed by the Engineer. The rock shall be installed over the entire width of the disturbed area and shall closely match the existing rock at each location. Several grades of rock may be required to attain this end, but it is not anticipated that more than one grade will have to be used at any one location. The cost for replacement of gravel or rock stabilized driveways and roadways shall be included in the overall Project cost bid unless a specific Bid Item is established in the Proposal.

Exhibit D – Additional Specifications

N. Backfill material shall consist of the suitable excavated material being stored for this purpose. Backfill material placed within 1-foot of piping and appurtenances shall not contain any stones or rocks larger than 2 inches in diameter, and no stones or rocks larger than 6 inches in diameter will be permitted in any backfill. Backfill material containing mangrove muck or other unsuitable materials shall not be used.

O. During the backfilling operation, care shall be taken to preserve the alignment and gradient of the installed pipe.

SHOP DRAWINGS, PRODUCT DATA, AND SAMPLES**PART 1 GENERAL****1.01 SCOPE OF WORK**

A. Before proceeding with the erection of the construction plan, including the setting or placing thereof, and the erection of other temporary structures, the Contractor shall furnish the Engineer with such information and plans as City may require.

B. Shop Drawings shall be submitted prior to any project construction activity. In a timely fashion, well before the contemplated ordering for fabrication of special order or long-lead items or construction use of any standard element of the work, the Contractor shall furnish Shop Drawings for the review and approval of City.

C. It is the Contractor's sole responsibility, upon the first occasion of submittal of a particular element of the work, to submit Shop Drawings of an element which match and fulfill the requirements and intent of the Plans and Specifications. Any delays or costs caused, either directly or indirectly, by non-timely submissions; submission of items differing significantly from the intent of the Plans and/or Specifications; repeated submission of, or argument over, rejected elements or changes required for acceptance; arguments with the criteria or requirements of the Plans or Specifications; or any other such similar activities shall be at the expense of the Contractor.

D. It is the intent of the Contract Documents that the Contractor shall, in the first instance, submit Shop Drawings of elements which meet or exceed the requirements of the Contract Documents and fit with the other elements of the work and the existing conditions. Activities such as those mentioned in Article 1.01 C, which are inimical to this intent will not be tolerated and may, at the sole discretion of the Engineer, subject the Contractor to costs for any delays, costs, damages or penalties suffered by the City due to such activities to include but not be limited to; extra engineering and overhead costs together with any liquidated or actual damages.

1.02 DESCRIPTION OF WORK

A. Submit to the Engineer for review and approval, Shop Drawings, test reports and data on materials, equipment, and material samples as required for the proper control of work, and as specified in the Specification sections. Shop Drawings shall be submitted for all materials and equipment to be furnished.

B. Within twenty calendar days after the effective date of the Contract, submit to the Engineer a complete list of preliminary data on items for which Shop Drawings are to be submitted. Included in this list shall be the names of all proposed manufacturers furnishing specified items. Review of this list by the Engineer shall in no way expressed or implied relieve the Contractor from submitting complete Shop Drawings and providing materials, equipment, etc., fully in accordance with the Specifications. This procedure is required in order to expedite final review of Shop Drawings.

C. Maintain an accurate updated Shop Drawing submittal log which shall include the following items:

1. Submittal Description and Number Assigned
2. Specification Section
3. Plans Sheet Number
4. Date to Engineer

5. Date Returned to Contractor (from Engineer)
6. Status of Submittal (Approved, Approved as Noted, Rejected/Resubmit)
7. Date of Resubmittal and Return (as Applicable)
8. Date Material Release (for Fabrication)
9. Projected Date of Fabrication
10. Projected Date of Delivery to Site
11. Status of O & M Manuals Submittal

1.03 CONTRACTOR'S RESPONSIBILITY

A. Furnish the Engineer with a schedule of Shop Drawings submittals, fixing the respective dates for the submission of Shop Drawings, the beginning of manufacture, testing and installation of materials, supplies and equipment. This schedule shall indicate those that are critical to the progress schedule.

B. Submit to the Engineer all plans and schedules sufficiently in advance of construction requirements to provide maximum time for checking and appropriate action from the time the Engineer receive them.

C. It is the duty of the Contractor to check and approve all plans, data and samples prepared by or for him before submitting them to the Engineer for review. Each and every copy of the Plans and data shall bear Contractor's stamp showing that they have been checked and approved. Shop Drawings submitted to the Engineer without the Contractor's stamp and approval shall be returned to the Contractor for conformance with this requirement before Engineer's review. Shop Drawings shall indicate any deviations in the submittal from requirements of the Project Documents and the Contractor shall state the reason why a deviation is required.

D. All submittals shall be accompanied by a transmittal letter prepared in duplicate containing the following information:

1. Date
2. Project Title and Number
3. Contractor's name and address
4. The number of each Shop Drawing, Data, and Sample submitted
5. Notification of Deviations from Project Documents
6. Submittal Log Number conforming to and referring to Specification Section Numbers. Submit three copies of Shop Drawings and of descriptive or product data submittals necessary to complement Shop Drawing. The Engineer will retain two sets.

F. After receiving approval by the Engineer, the Contractor shall be responsible for submitting the Shop Drawings to the Building Department. Shop Drawings of all premanufactured items and all other Shop Drawings are required to obtain approval prior to manufacturing or installing the submitted items. The Contractor shall also be responsible for contesting any interpretations by the Building Department that City considers non-acceptable. The Contractor shall include in the bid prices, all costs for permits, fees and expenses associated with the submittals, including resubmittals (if any) of Shop Drawings to the Building Department. The Building Department as used in this paragraph shall be taken to mean the Miami-Dade County Building Department and/or other governing building authority appropriate to this project.

G. Do not begin any of the work covered by a drawing, data, or a sample returned as "Rejected/Resubmit" until a revision or correction thereof has been reviewed and returned to the Contractor, by the Engineer, with approval

or approval “As Noted”. Be responsible for and bear all costs of damages which may result from the ordering of any material or from proceeding with any part of work prior to receiving Engineer's approval or approval “As Noted” of the necessary Shop Drawings.

H. Be fully responsible for observing the need for and for making any changes in the arrangement of piping, connections, wiring, manner of installation, etc., which may be required by the materials/equipment the Contractor proposes to supply, both as they pertain to the Contractor's own work, work of others, or of other Divisions herein or Trades and clearly show such changes on the Shop Drawings.

I. When substitutions in materials or equipment are allowed, the Contractor shall make all necessary changes in adjacent or connected structures and equipment at his expense. Where contemplated changes, substitutions or appurtenant work require engineering design, in the opinion of the Engineer, the Contractor shall have such design services performed at his expense. Said engineering design services shall be of an extent satisfactory to the Engineer whose word shall be final and shall be performed by a Registered Professional Engineer licensed to practice in the State of Florida.

J. When substitutions in materials or equipment are allowed, the Contractor shall be solely responsible for all costs and time required by any differences in construction methods, fabrication or assembly required and no additional time will be allowed.

K. The Miami-Dade Building Department requires that any changes made during construction which result in differences between the as constructed arrangement/elements and the arrangement/elements shown on the permitted plans be reconciled by re-permitting of the plan sheet or sheets affected by the construction changes prior to inspection. Thus, the plan sheet or sheets must be redrawn to reflect the construction change, signed, sealed, dated and re-submitted by the Engineer of Record for re-permitting.

L. When a construction change, initiated by the Contractor or resulting from a change made by the Contractor, requires re-permitting as discussed in the preceding paragraph, the Contractor shall be responsible for all labor, material and equipment required to redraw the Plan sheet or sheets affected by the change to the satisfaction of the Engineer of Record and City. The costs for all work of this sort and all costs of re-permitting shall be borne by the Contractor and no extra compensation will be allowed.

M. Determine and verify:

1. Field measurements
2. Field construction criteria
3. Catalog numbers and similar data
4. Conformance with specifications
5. That installation and maintenance clearances are sufficient particularly when equipment or arrangement changes have been made

1.04 ENGINEER'S REVIEW OF SHOP DRAWINGS

A. Engineer's review of plans, data and samples, submitted by the Contractor will cover only general conformity to the Drawing and Specifications. The Engineer's review will not constitute an approval of dimensions, quantities, and details of the material, equipment, device, or item shown. The review of plans and schedules will be general, and shall not be construed:

1. As permitting any departure from the Contract requirements
2. As relieving the Contractor of responsibility for any errors, including detail, dimensions, and materials
3. As approving departures from details furnished by the Engineer, except as otherwise provided herein

B. Variations

1. If the plans or schedules, as submitted, describe variations per paragraph 1.03 C, and show a departure from the Contract requirements which Engineer finds to be in the interest of the City and to be so minor as not to involve a change in Contract price or time for performance, the Engineer may return the reviewed plans without noting an exception.

2. If the plans or schedules, as submitted, describe variations and show a departure from the Contract requirements which the Engineer finds to be minor enough to be corrected by redlining the submittal, the engineer will mark and return the submittal marked "Approved as Noted." The redlined corrections shall be as binding on the Contractor as would be a resubmission embodying the same corrections.

C. When reviewed by the Engineer, each of the Shop Drawings shall be stamped and dated to indicate it had been reviewed. Shop Drawings stamped "Revise and Resubmit" and with required corrections shown will be returned to the Contractor for correction and resubmittal.

D. Resubmittals will be handled in the same manner as first submittals. On resubmittals the Contractor shall direct specific attention, in writing or on resubmitted Shop Drawings, to revisions and corrections required by the Engineer on previous sub- missions. The Contractor shall make any corrections required by the Engineer.

E. If the Contractor considers any correction indicated on the Shop Drawings to constitute a change to the Project Plans or Specifications, the Contractor shall give written notice thereof to the Engineer who will render a decision which shall be final. After the decision has been made, the Contractor shall without delay, provide the corrections to the plans.

F. When the Shop Drawings have been approved by the Engineer, the Contractor shall carry out the construction in accordance therewith and shall make no further changes therein except upon written instructions from the Engineer.

G. No partial submittals will be reviewed. Submittals not complete will be returned to the Contractor for resubmittal. Unless otherwise specifically permitted by the Engineer, all submittals shall be made in groups containing all associated items for systems, processes or as indicated in specific specifications sections. All plans, schematics, manufacturer's product data, certifications and other Shop Drawing submittals required by a system specification shall be submitted at one time as a package to facilitate interface checking.

1.05 SHOP DRAWINGS

A. When used in the Project Documents, the term "Shop Drawings" shall be considered to mean Contractor's plans for materials and equipment which become an integral part of the Project. These Shop Drawings shall be complete and detailed. Shop Drawings shall consist of fabrication, erection and setting drawings and schedule drawings, manufacturer's scale drawings, and wiring and control diagrams. Cuts, catalogs, pamphlets, descriptive literature, and performance/test data shall be considered only as supportive to required Shop Drawings as defined above.

B. Manufacturer's catalog sheets, brochures, diagrams, illustrations and other standard descriptive data shall be clearly marked to identify pertinent materials, product or models. Information which is not applicable to the Work shall be deleted by striking or cross hatching.

C. Each Shop Drawing shall have a blank area 3½ inches by 3½ inches, located adjacent to the title block. The title block shall display the following:

1. Project Title and Number
2. Name of Project Building or Structure
3. Number and Title of the Shop Drawing
4. Date of Shop Drawing or Revision
5. Name of Contractor and Subcontractor Submitting Drawing
6. Supplier/Manufacturer
7. Separate Detailer when Pertinent
8. Specification Title and Number
9. Specification Section
10. Application Project Drawing Number

D. If plans show variations from Contract requirements because of standard shop practice or for other reasons, describe such variations in the letter of transmittal. If no explanation of these variations is provided, the Contractor shall not be relieved of the responsibility for executing the work in accordance with the Contract, even though such plans have been reviewed and approved.

E. For all mechanical and electrical equipment furnished, provide a list including the equipment name, address of and telephone number of the manufacturer's representative and service company so that service and/or spare parts can be readily obtained.

F. All manufacturers or equipment suppliers who propose to furnish equipment or products shall submit an installation list to the Engineer along with the required Shop Drawings. The installation list shall include at least five installations where identical equipment has been installed and has been in operation for a period of at least five years, unless otherwise specified. Manufacturers and/or equipment which fails to meet the specified experience period will be considered if the manufacturer or supplier provides a bond or cash deposit which will guarantee replacement of the equipment or process in the event of failure or unsatisfactory service.

G. Only the Engineer will utilize the color "red" in marking Shop Drawing submittals.

1.06 REQUIRED INFORMATION

A. Submit, as applicable, the following for all prefabricated or manufactured structural, mechanical, electrical, plumbing, process system, and equipment work:

1. Shop Drawings or equipment drawings, including dimensions, size and location of connections to other work, and weight of equipment
2. Catalog information and cuts
3. Installation or placing plans for equipment, drives, and bases
4. Supporting calculations, signed and sealed by a Florida Registered Engineer when required, for

equipment and associated supports, or hangers required or specified to be designed by equipment manufacturers.

5. Signed and sealed calculations and plans by in-house Florida Registered Professional Engineer for structural systems, indicating compliance to the structural design criteria specified in the Plans.
6. Complete manufacturer's specifications, including materials description and paint system.
7. Performance data and pump curves
8. Suggested spare parts with current price information
9. List of special tools required for testing, checking, parts replacement, and maintenance. (Special tools are those which have been specially designed or adapted for use on parts of the equipment, and are not customarily and routinely carried by maintenance mechanics)
10. List of special tools furnished with the equipment
11. List of materials and supplies required for the equipment prior to, and during startup
12. List of materials or supplies furnished with the equipment
13. Special handling instructions
14. Requirements for storage and protection prior to installation
15. Requirements for routine maintenance required prior to equipment startup
16. List of all requested exceptions to the Project Documents

1.07 SUBMITTAL REQUIRED FOR FOREIGN MANUFACTURED ITEMS

A. In addition to the submittal requirements stated above, suppliers of foreign manufactured items shall submit the names and addresses of companies within the United States that maintain technical service representatives and a complete inventory of spare parts and accessories for each foreign-made item proposed for incorporation into the Work. Failure to prove these capabilities shall be cause for rejection of the foreign manufactured items.

B. Foreign manufactured equipment and materials shall in all cases be clearly and permanently marked with the manufacturer's name and country of origin of the item. The name of the U.S. importing/supplying firm is not acceptable. Shop Drawing submittals of foreign-made items shall be accompanied by written information to include name and location (i.e. country, City, and street address) of the manufacturer. This requirement shall also apply to the foreign made elements of items assembled in this country from parts wholly or partially manufactured overseas.

1. The words, "Permanently Marked" as used in this paragraph shall mean; die stamped, cast-in, welded, or otherwise marked such that the removal of the marking by any mechanical or chemical means will result in obvious permanent damage to the surface marked. These markings shall be on surfaces which are not hidden by assembly.

C. Where specified elsewhere herein or at the sole discretion of the Engineer, whose word shall be final, supply verification of quality, suitability, or other aspects, as directed by the Engineer, from a Professional Engineer licensed to practice in the State of Florida or the state where the supplying U.S. firm is located. The verification shall be signed, sealed, and dated. All costs for this verification shall be at the sole expense of the Contractor and no extra compensation will be allowed. Verification by foreign-based engineers, firms, manufacturers, etc. will not be acceptable. Verification by means of a very stringent foreign testing agency/standard (for example ISO 9000 series) may be acceptable. However, this shall again be at the sole discretion of the Engineer and the full burden of proof and satisfaction of City shall rest with the Contractor. No extra time will be permitted due to the requirement for verification and the Contractor has the sole responsibility to make his submittals with all necessary information in a timely fashion.

D. Items which are fabricated (i.e. assembled in this country from partially or wholly foreign manufactured parts) may also be required to have verification of their foreign made elements as specified for wholly foreign made items in the preceding paragraph.

E. Any items in contact with or being added to potable water shall conform with NSF/ANSI 61 or 60, as appropriate.

1.08 SAMPLES

A. Furnish for the approval of the Engineer, samples required by the Project Documents or required by the Engineer. Samples shall be delivered to the Engineer as specified or directed. The Contractor shall prepay all shipping charges on samples. Materials or equipment for which samples are required shall not be used in work until approved by the Engineer.

B. Samples shall be of sufficient size and quantity to clearly illustrate:

1. Functional characteristics of the product, with integrally related parts and attachment devices
2. Full range of color, texture and pattern
3. A minimum of two samples of each Item shall be submitted

C. Each sample shall have a label indicating:

1. Name of Project
2. Material or Equipment Represented
3. Name of Producer and Brand (if any)
4. Location in Project

D. Prepare a transmittal letter in triplicate for each shipment of samples containing the information specified herein in Paragraph 1.06 A. Enclose a copy of this letter with the shipment and send a copy of this letter to the Engineer. Approval of a sample shall be only for the characteristics or use specified and shall not be construed to change or modify any Contract requirements.

E. Approved samples of the hardware in good condition will be marked for identification and may be used in the work. Materials and equipment incorporated in work shall match the approved samples. Samples which failed testing or were not approved shall be returned to the Contractor at his expense, if so, requested at time of submission.

1.09 SUBSTITUTIONS

A. Changes in products, materials, equipment, and methods of construction required by the Contract Documents, which are proposed by the Contractor after award of the Contract, are considered to be requests for substitutions. Where the Plans and/or Specifications designate the products of a particular manufacturer, the product specified has been found suitable for the intended use. Articles or products of similar characteristics may be offered for the approval of the Engineer, whose decision shall be final. Copies of complete descriptive data shall be furnished regarding all materials furnished by the Contractor, consisting of Dimension drawings, catalog references, product data, cost, and other information necessary to clearly identify and evaluate each article. When substitutions are permitted, the Contractor shall make all necessary changes in adjacent, connected, or

other structures and equipment at his expense.

B. Where engineer-recommended changes, substitutions or appurtenant work require engineering design, the Contractor shall have such design services performed. Those engineering design services shall be of an extent satisfactory to the Engineer, whose decision shall be final. Engineering services for engineer-recommended changes, substitutions or appurtenant work, shall be performed by a Registered Professional Engineer licensed to practice in the State of Florida.

C Unless specifically authorized by the Engineer in writing, no additional contract time will be allowed, and a decrease in time may be appropriate.

FORM OF BID BOND

STATE OF)
COUNTY OF)

KNOW ALL MEN BY THESE PRESENTS, that we, _____, as Principal, and _____, as Surety, are held firmly bound unto the City of Doral, a municipal corporation of the State of Florida in the sum of _____ Dollars (\$ _____), lawful money of the United States, for the payment of which sum and truly to be made, we bind ourselves, our heirs, executors, administrators and successors jointly and severally, firmly by these presents.

THE CONDITION OF THIS OBLIGATION IS SUCH that the Principal has submitted the Bid dated _____, 20__ for: _____.

WHEREAS, it was a condition precedent to the submission of said Bid that a or Bid Bond in the amount of five percent (5%) of the Base Bid be submitted with said Bid as a guarantee that the BIDDER would, if awarded the Contract, enter into a written Contract with the City for the performance of said Contract, within ten (10) consecutive calendar days after written notice having been given of the Award of the Contract.

NOW, THEREFORE, the conditions of this obligation are such that if the Principal within ten (10) consecutive calendar days after written notice of such acceptance, enters into a written Contract with the City of Doral and furnishes the Performance and Payment Bonds, satisfactory to the City, each in an amount equal to one hundred percent (100%) of the Contract Price, and provides all required Certificates of Insurance, then this obligation shall be void; otherwise the sum herein stated shall be due and payable to the City of Doral and the Surety herein agrees to pay said sum immediately, upon demand of the City, in good and lawful money of the United States of America, as liquidated damages for failure thereof of said Principal.

IN WITNESS WHEREOF, the above bonded parties have executed this instrument under their several seals this _____ day of _____, 20____, the name and the corporate seal of each corporate party being hereto affixed and these presents being duly signed by its undersigned representative.

IN PRESENCE OF:

(Individual or Partnership Principal)

_____ (SEAL)
(Business Name)

(Business Address)

ATTEST:

(Corporate Surety)

(City/State/Zip)

(Business Phone)

FORM OF PAYMENT BOND

STATE OF)
COUNTY OF)

KNOW ALL MEN BY THESE PRESENTS, that pursuant to the requirements of Florida Statute 255.05, we, as Principal, hereinafter called Contractor, and , as Surety, are bound to the City of Doral, Florida as Obligee, hereinafter called City, in the amount of Dollars (\$) for the payment whereof Contractor and Surety bind themselves, their heirs, executors, administrators, successors and assigns, jointly and severally.

WHEREAS, Contractor has by written agreement entered into a Contract, ITB NO. XXXX-XX, awarded the day of , 20__, with the City of Doral for [project name] in accordance with specifications prepared by the City of Doral which Contract is by reference made a part hereof, and is hereafter referred to as the Contract;

THE CONDITION OF THIS BOND is that if the Contractor:

1. Indemnifies and pay Obligee all losses, damages (including, but not limited to, damages for delay (specifically, liquidated damages as per section 00710 – General Conditions of the ITB and section 3.4 of the Construction Contract) and actual damages caused or arising out of the acts, omissions or negligence of Contractor), expenses, costs, and attorney’s fees including attorney’s fees incurred in appellate proceedings, that Obligee sustain because of default by Contractor under the Contract; and

2. Promptly makes payments to all claimants as defined by Florida Statute 255.05(1) supplying Contractor with all labor, materials and supplies used directly or indirectly by Contractor in the prosecution of the Work provided for in the Contract, then this obligation shall be void; otherwise, it shall remain in full force and effect subject, however, to the following conditions:

2.1 A claimant, except a laborer, who is not in privity with the Contractor and who has not received payment for their labor, materials, or supplies shall, within forty-five (45) days after beginning to furnish labor, materials, or supplies for the prosecution of the Work, furnish to the Contractor a notice that they intend to look to the Bond for protection.

2.2 A claimant who is not in privity with the Contractor and who has not received payment for their labor, materials, or supplies shall, within ninety (90) days after performance of the labor, or after complete delivery of the materials or supplies, deliver to the Contractor and to the Surety, written notice of the performance of the labor or delivery of the materials or supplies and of the non-payment.

2.3 No action for the labor, materials, or supplies may be instituted against Contractor or the Surety unless the notices stated under the preceding paragraphs 2.1 and 2.2 have been given.

2.4 Any action under this Bond must be instituted in accordance with the Notice and Time Limitations provisions prescribed in Section 255.05(2), Florida Statutes.

The Surety hereby waives notice of and agrees that any changes in or under the Contract Documents and compliance or noncompliance with any formalities connected with the Contract or the changes do not affect the Surety's obligation under this Bond.

IN WITNESS WHEREOF, the above bonded parties have executed this instrument under their several seals this _____ day of _____, 20____, the name and the corporate seal of each corporate party being hereto affixed and these presents being duly signed by its undersigned representative.

IN PRESENCE OF:

(Individual or Partnership Principal)

_____ (SEAL)
(Business Name)

(Business Address)

ATTEST:

(Corporate Surety)

(City/State/Zip)

(Business Phone)

FORM OF PERFORMANCE BOND

STATE OF)
COUNTY OF)

KNOW ALL MEN BY THESE PRESENTS, that pursuant to the requirements of Florida Statute 255.05, we, as Principal, hereinafter called Contractor, and , as Surety, are bound to the City of Doral, Florida, as Obligee, hereinafter called City, in the amount of Dollars (\$) for the payment whereof Contractor and Surety bind themselves, their heirs, executors, administrators, successors and assigns, jointly and severally.

WHEREAS, Contractor has by written agreement entered into a Contract, ITB NO. XXXX-XX, awarded the day of, 20__, with City of Doral for [project name] in accordance with drawings (plans) and specifications which Contract is by reference made a part hereof, and is hereafter referred to as the Contract;

THE CONDITION OF THIS BOND is that if the Contractor:

1. Fully performs the Contract between the Contractor and the City for: [project name] as scheduled after the date of Contract commencement as specified in the Notice to Proceed and in the manner prescribed in the Contract; and bid specifications.
2. Indemnifies and pay Obligee all losses, damages (including, but not limited to, damages for delay (specifically, liquidated damages as per section 00710 – General Conditions of the ITB and section 3.4 of the Construction Contract) and actual damages caused or arising out of the acts, omissions or negligence of Contractor), expenses, costs, and attorney’s fees including attorney’s fees incurred in appellate proceedings, that Obligee sustain because of default by Contractor under the Contract; and
3. Upon notification by the City of Doral, corrects any and all defective or faulty Work or materials which appear within ONE (1) YEAR.
4. Performs the guarantee of all Work and materials furnished under the Contract for the time specified in the Contract, then this Bond is void, otherwise it remains in full force. Whenever Contractor shall be, and declared by City to be, in default under the Contract, the City having performed their obligations thereunder, the Surety may promptly remedy the default, or shall promptly:
 - 4.1 Complete the Contract in accordance with its terms and conditions; or
 - 4.2 Obtain a Bid or Bids for completing the Contract in accordance with its terms and conditions, and upon determination by Surety of the best, lowest, qualified, responsible and responsive BIDDER, or, if the City elects, upon determination by the City, and Surety jointly of the best, lowest, qualified, responsible and responsive BIDDER, arrange for a Contract between such BIDDER and City, and make available as Work progresses (even though there should be a default or a succession of defaults under the Contract or Contracts of completion arranged under this paragraph) sufficient funds to pay the cost of completion less the balance of the Contract Price; but not exceeding, including other costs and damages for which the Surety may be liable hereunder, the amount set forth in the first paragraph hereof. The term "balance of the Contract Price." as used in this paragraph, shall mean the total amount payable by City of Doral to Contractor under the Contract and any amendments thereto, less the amount properly paid by City of Doral to Contractor.

No right of action shall accrue on this Bond to or for the use of any person or Corporation other than the City named herein.

Surety hereby waives notice of and agrees that any changes in or under the Contract Documents and compliance or noncompliance with any formalities connected with the Contract or the changes do not affect Surety's obligation under this Bond.

Signed and sealed this day of, 20__.

IN WITNESS WHEREOF, the above bonded parties have executed this instrument under their several seals this _____ day of _____, 20____, the name and the corporate seal of each corporate party being hereto affixed and these presents being duly signed by its undersigned representative.

IN PRESENCE OF:

(Individual or Partnership Principal)

_____ (SEAL)
(Business Name)

(Business Address)

ATTEST:

(Corporate Surety)

(City/State/Zip)

(Business Phone)

CITY OF DORAL

**TRAFFIC CALMING IMPROVEMENTS: SECTION 7
ROADWAY PLANS**

INDEX OF ROADWAY PLANS

SHEET NO.	SHEET DESCRIPTION
1	KEY SHEET
2	SUMMARY OF QUANTITIES
3 - 4	GENERAL NOTES
5 - 6	ROADWAY PLAN



CITY COUNCIL

- MAYOR
CHRISTI FRAGA
- VICE MAYOR
RAFAEL PINEYRO
- COUNCILWOMAN
DIGNA CABRAL
- COUNCILWOMAN
MAUREEN PORRAS
- COUNCILMAN
OSCAR PUIG-CORVE
- PUBLIC WORKS DIRECTOR
CARLOS ARROYO

**SEG. 1 END PROJECT
STA. 13+61.00**

☒ SURVEY NW 114th CT

**SEG. 1 BEGIN PROJECT
STA. 11+39.00**

☒ SURVEY NW 114th CT

**SEG. 2 BEGIN PROJECT
STA. 12+39.00**

☒ SURVEY NW 86th ST

**END PROJECT
SEG. 2 STA. 14+61.00**

☒ SURVEY NW 86th ST

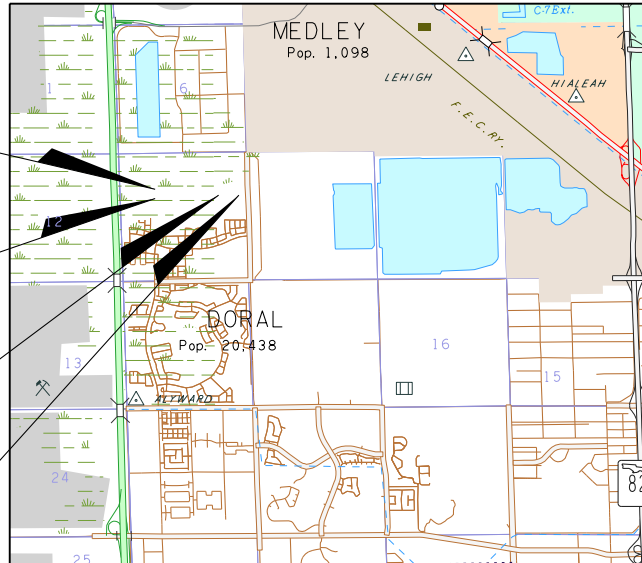

NOTE:
SCALE OF THESE PLANS MAY HAVE
CHANGED DUE TO REPRODUCTION

LENGTH OF PROJECT

	SEGMENT 1		SEGMENT 2		TOTAL	
	LF	MILES	LF	MILES	LF	MILES
ROADWAY	260	0.049	260	0.049	520	0.980
EXCEPTIONS						
GROSS LENGTH OF PROJECT	260	0.049	260	0.049	520	0.980
EXCEPTIONS						
NET LENGTH OF JOB	260	0.049	260	0.049	520	0.980

PLANS PREPARED FOR
CITY OF DORAL

BY

ENGINEER OF RECORD:

MANUEL A. SAULEDA, P.E.
P.E. NO.: 45988
8750 N.W. 36TH STREET, SUITE 360
MIAMI, FLORIDA 33178
TEL: (305) 503-9873; FAX: (305) 503-9882

Manuel A Sauleda
Manuel A Sauleda
2023.07.28
13:11:13-04'00'

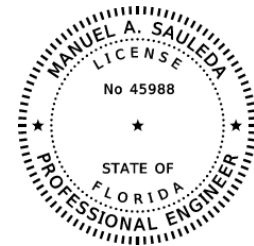

THESE PLANS HAVE BEEN PREPARED IN ACCORDANCE WITH AND ARE GOVERNED BY THE FLORIDA DEPARTMENT OF TRANSPORTATION, STANDARD PLANS 2019-2020, AND SPECIFICATIONS JULY 2019, FOR ROAD AND BRIDGE CONSTRUCTION AND MAINTENANCE FOR STREETS AND HIGHWAYS AS AMENDED BY CONTRACT DOCUMENTS, MIAMI-DADE COUNTY PUBLIC WORKS DEPARTMENT STANDARDS AND SPECIFICATIONS PART 1, 2, AND 3, THE MIAMI-DADE COUNTY PUBLIC WORKS DEPARTMENTS - HIGHWAY DIVISION STANDARD DETAILS.

MANUEL A. SAULEDA
FLORIDA REGISTRATION P.E., NO. 45988

SHEET
NO.

1

SUMMARY OF QUANTITIES

PAY ITEM NO.	DESCRIPTION	UNIT	SHEET NUMBERS												TOTAL THIS SHEET		GRAND TOTAL		
			5		6		7		8		9		10		PLAN	FINAL	PLAN	FINAL	
			PLAN	FINAL	PLAN	FINAL	PLAN	FINAL	PLAN	FINAL	PLAN	FINAL	PLAN	FINAL	PLAN	FINAL			
101-1	MOBILIZATION	LS	1																
102-1	MAINTENANCE OF TRAFFIC	LS	1																
110-1-1	CLEARING AND GRUBBING	AC	0.0030																
334-1-53	SUPERPAVE ASPHALTIC CONCRETE, TRAFFIC C., PG 76-22	TN	8.56																
522-2	CONCRETE SIDEWALK AND DRIVEWAYS, 6" THICK	SY	-																
527-2	DETECTABLE WARNINGS	SF	-																
570-1-3	PERFORMANCE TURF, SOD AND SOIL, SHOULDER TREATMENT INDEX 570-010	SY	14.7																

PAY ITEM NOTES:
110-1-1: XX AC.

DATE	DESCRIPTION	DATE	DESCRIPTION

MANUEL A. SAULEDA, P.E.
P.E. LICENSE NUMBER 45988
H. W. LOCHNER, INC.
CONSULTING ENGINEERS AND PLANNERS
8750 NW 36th STREET, SUITE 360
MIAMI, FLORIDA - 33176

TRAFFIC CALMING DEVICES PROJECT
VARIOUS LOCATIONS
LIMENDEZ

CITY OF DORAL



4/24/2023 4:52:23 PM

SUMMARY OF QUANTITIES

SHEET NO. 2



GENERAL NOTES

1. GENERAL NOTES ON THE PROJECT PLANS AND DRAWINGS ARE SOLELY TO AID AND ASSIST THE CONTRACTOR WITH THE FIELD OPERATIONS FOR THIS PROJECT. SAID GENERAL NOTES MAY NOT FULLY DESCRIBE ALL OF THE REQUIREMENTS FOR AN ITEM. THEREFORE, THE CONTRACTOR SHALL READ AND VERIFY THE CONTRACT DOCUMENTS, INCLUDING BUT NOT LIMITED TO THE PLANS, SPECIFICATIONS, GENERAL TERMS AND CONDITIONS, AND ANY SUPPLEMENTAL TERMS AND CONDITIONS, TO FULLY UNDERSTAND AND COMPLY WITH ALL THE REQUIREMENTS THEREIN.
2. THE INFORMATION PROVIDED ON THE PLANS IS BASED ON THE BEST AVAILABLE INFORMATION AND SHOULD BE CONSIDERED APPROXIMATE. THE CONTRACTOR SHALL BE RESPONSIBLE FOR CONDUCTING ANY AND ALL INVESTIGATIONS DEEMED NECESSARY TO CONFIRM OR VERIFY ACTUAL FIELD CONDITIONS PRIOR TO BIDDING. ANY IDENTIFIED DISCREPANCIES SHALL BE REPORTED TO THE CITY OF DORAL AND THE ENGINEER OF RECORD PRIOR TO CONSTRUCTION COMMENCEMENT.
3. REFER TO THE SURVEY PREPARED BY HADOME CORP. FOR HORIZONTAL AND VERTICAL CONTROL. ALL ELEVATIONS SHOWN WITH THE PROJECT PLANS REFER TO THE NATIONAL GEODETIC VERTICAL DATUM OF 1929 (NGVD 1929).
4. ALL PUBLIC LAND CORNERS AND PRIMARY NETWORK CONTROL SURVEY MONUMENTS ARE TO BE PROTECTED BY THE CONTRACTOR. CORNERS AND MONUMENTS WITHIN THE WORK ZONE AND IN DANGER OF BEING DAMAGED, DESTROYED OR COVERED SHALL BE PROTECTED BY A REGISTERED LAND SURVEYOR IN ACCORDANCE WITH THE MINIMUM TECHNICAL STANDARDS OF THE FLORIDA BOARD OF PROFESSIONAL LAND SURVEYORS PRIOR TO THE BEGINNING OF WORK. UPON PROJECT COMPLETION, THE CONTRACTOR SHALL RESTORE ALL SUCH CORNERS AND MONUMENTS AND SHALL FURNISH TO THE CITY OF DORAL PUBLIC WORKS DEPARTMENT A SIGNED AND SEALED COPY OF THE LAND SURVEYOR'S REFERENCE DRAWING.
5. ANY NGVD 1929 BENCHMARK MONUMENTS WITHIN THE LIMITS OF CONSTRUCTION ARE TO BE PROTECTED AND PROPERLY REFERENCED BY A REGISTERED LAND SURVEYOR IN ACCORDANCE WITH THE MINIMUM TECHNICAL STANDARDS OF THE FLORIDA BOARD OF PROFESSIONAL LAND SURVEYORS. PRIOR TO BEGINNING WORK AT THE PROJECT SITE, IF ANY MONUMENT IS IN DANGER OF DAMAGE, THE PROJECT ENGINEER SHALL NOTIFY DENIS RIORDAN FLORIDA STATE GEODETIC ADVISOR NG044/NGS/INGS TELEPHONE (240) 678-2107.
6. SECTION 5-3, CONFORMITY OF WORK WITH CONTRACT DOCUMENTS, WITHIN DIVISION 1, OF THE FDOT STANDARD SPECIFICATIONS SHALL BE REVISED TO REQUIRE THAT ALL FINISHED GRADES (FOR BASE AND SURFACE COURSES) VARY NO MORE THAN 0.05 FEET FROM THE GRADES SHOWN IN THE PLANS.
7. ALL EXCESS MATERIAL AS DESIGNATED BY THE ENGINEER IS TO BE DISPOSED BY THE CONTRACTOR IN AREAS PROVIDED BY HIM ON A DAILY BASIS AND IN A LEGAL MANNER AT THE CONTRACTOR'S EXPENSE. ACCUMULATION OF DEBRIS OR STOCKPILING OF MATERIAL WITHIN THE PROJECT LIMITS WILL NOT BE ALLOWED. ALL EXCAVATED MATERIAL SHALL BE TESTED FOR CONTAMINANTS PRIOR TO OFF-SITE DISPOSAL.
8. THE CONTRACTOR SHALL SECURE THE WORK SITE TO PROTECT THE PUBLIC HEALTH AND WELFARE.
9. THE CONTRACTOR SHALL VERIFY, PHOTOGRAPH AND INVENTORY THE EXACT LOCATIONS OF EXISTING LANDSCAPING, STRUCTURES, UTILITIES, AND OTHER FEATURES WHICH ARE TO BE REMOVED, DAMAGED, EXPOSED OR IN ANY WAY DISTURBED BY THE CONSTRUCTION OF THIS PROJECT. THESE FEATURES SHALL BE RESTORED PROMPTLY TO ITS ORIGINAL CONDITIONS BY THE CONTRACTOR AT NO ADDITIONAL COST TO THE CITY OF DORAL.
10. THE CONTRACTOR SHALL RESTORE ALL EXISTING SODDED AREAS OF THE PROJECT WHICH ARE DISTURBED BY THE CONSTRUCTION ACTIVITIES TO THEIR EXISTING CONDITIONS AT NO ADDITIONAL COST TO THE CITY OF DORAL.
11. ALL CONSTRUCTION LAYOUT SHALL BE THE RESPONSIBILITY OF THE CONTRACTOR.
12. THE CONTRACTOR SHALL PAINT VISIBLE STATION MARKS WITH STENCILED NUMBERS AS FOLLOWS:
 - A. WHERE THE EXISTING CURB IS "TO REMAIN", PAINTED ON THE FACE OF CURB FROM THE BEGINNING OF THE PROJECT.
 - B. AT NEW CURB LOCATIONS, PAINTED ON THE FACE OF CURB NO LATER THAN 72 HOURS FROM BEING POURED.
 - C. WHERE CURB DOES NOT EXIST AND IS NOT PROPOSED, THE CONTRACTOR SHALL MAINTAIN VISIBLE STATIONING WITH SURVEYING STAKES.
13. THE CONTRACTOR SHALL NOTIFY THE CITY AND ADJACENT PROPERTY OWNERS IN WRITING AT LEAST 48 HOURS PRIOR TO COMMENCEMENT OF CONSTRUCTION.
14. THE CONTRACTOR SHALL BE RESPONSIBLE FOR PROVIDING A PROPER STAGING AREA. THE LOCATION OF THIS STAGING AREA SHALL BE APPROVED BY THE CITY.
15. ANY MATERIAL TO BE STOCKPILED FOR PERIODS GREATER THAN 24 HOURS SHALL BE PROTECTED BY THE APPROPRIATE EROSION CONTROL DEVICES.
16. THE CONTRACTOR SHALL BE RESPONSIBLE TO SATISFY ALL REQUIREMENTS OF ANY REGULATORY AGENCY PERMIT IN REGARDS TO CONSTRUCTION ACTIVITIES AND RELATED CONDITIONS PRIOR TO THE START OF CONSTRUCTION.
17. THE CONTRACTOR SHALL MAINTAIN SAFE PEDESTRIAN AND VEHICULAR ACCESS TO ALL ADJACENT PROPERTIES. THE LEVEL OF ACCESS REQUIRED FOR THE ADJACENT PROPERTIES SHALL BE COORDINATED BY THE CONTRACTOR WITH THE CITY OF DORAL.
18. THE CONTRACTOR SHALL NOT ENCRUCH INTO PRIVATE PROPERTY WITH PERSONNEL, MATERIAL, AND/OR EQUIPMENT. ALL PROPOSED WORK SHALL BE PERFORMED WITHIN THE LIMITS OF THE EXISTING STATE/LOCAL RIGHT-OF-WAY, AND ALL IMPROVEMENTS SHALL BE CONSTRUCTED AND INSTALLED WITHIN SAID LIMITS, UNLESS OTHERWISE DIRECTED BY THE CITY OF DORAL.
19. THE CONTRACTOR SHALL NOTIFY THE ENGINEER OF RECORD, IN WRITING IMMEDIATELY IF ANY CONFLICT ARISES DURING CONSTRUCTION FOR ANY OF THE IMPROVEMENTS SHOWN IN THE PROJECT PLANS.

20. THE CONTRACTOR SHALL USE A STREET SWEEPER (USING WATER) OR OTHER EQUIPMENT CAPABLE OF CONTROLLING AND REMOVING DUST. APPROVAL OF THE USE OF SUCH EQUIPMENT IS CONTINGENT UPON ITS DEMONSTRATED ABILITY TO DO THE WORK.
21. IF SHEETING, SHORING, OR DEWATERING (INCLUDING WELL POINTS IF NECESSARY), THE CONTRACTOR MUST MONITOR AND CONTROL ALL WORK THAT MAY CAUSE CRACKING TO ANY ADJACENT BUILDING, STRUCTURE OR PROPERTY AREA. THE CONTRACTOR SHALL BE RESPONSIBLE FOR ANY DAMAGES CAUSED BY THESE OPERATIONS. ASSOCIATED COSTS FOR THIS WORK SHALL BE INCLUDED IN THE RELATED BID ITEM FOR THE TYPE OF WORK BEING DONE. THE COST OF THIS WORK SHALL BE INCLUDED IN THE MAINTENANCE OF TRAFFIC PAY ITEM.
22. THE CONTRACTOR SHALL BE RESPONSIBLE FOR OBTAINING A DEWATERING PERMIT IN THE EVENT IT IS REQUIRED. COST OF PERMIT AND DEWATERING ACTIVITY SHALL BE INCLUDED IN THE RELATED BID ITEM FOR THE WORK BEING DONE. UNDER NO CIRCUMSTANCE SHALL THE CONTRACTOR DISCHARGE DEWATERING EFFLUENT INTO THE EXISTING DRAINAGE SYSTEM.
23. THE CONTRACTOR SHALL BE RESPONSIBLE FOR SUBMITTING TO THE FLORIDA DEPARTMENT OF ENVIRONMENTAL PROTECTION (FDEP) AN NPDES NOT AND OBTAINING AN NPDES CONSTRUCTION GENERAL PERMIT (CGP).
24. THE CONTRACTOR SHALL REMOVE ALL SEDIMENT BARRIERS AND ROCK BAGS AT THE COMPLETION OF THE PROJECT.
25. THE CONTRACTOR SHALL BE RESPONSIBLE FOR THE IMMEDIATE REMOVAL OF STORMWATER FROM THE ROADWAY WITHIN THE PROJECT LIMITS AND BE IN COMPLIANCE WITH NPDES AND OTHER PERMIT REQUIREMENTS. PROVISIONS SHALL BE SUBMITTED TO THE CITY OF DORAL FOR APPROVAL BEFORE USE. THIS COST SHALL BE INCLUDED IN THE MAINTENANCE OF TRAFFIC PAY ITEM.
26. SAW-CUTTING OF THE EXISTING SIDEWALKS SHALL BE MADE ONLY AT THE NEAREST FLAG JOINTS.
27. THE CONTRACTOR SHALL ASSIST THE CITY WITH THE HANDLING OF PUBLIC INFORMATION MATERIALS, INCLUDING CITIZEN NOTIFICATION LETTERS AND PROJECT CONSTRUCTION SIGNS, PRIOR TO THE START OF EACH SIGNIFICANT PHASE OF CONSTRUCTION. COST OF THIS WORK SHALL BE INCLUDED IN THE MAINTENANCE OF TRAFFIC PAY ITEM.
28. CLEARING & GRUBBING, AND OTHER INCIDENTAL WORK NECESSARY FOR HARMONIZATION OUTSIDE OF THE R/W SHALL BE INCLUDED IN RELATED BID ITEMS.
29. THE CONTRACTOR SHALL TAKE PHOTOS OF THE EXISTING PAVEMENT MARKINGS PRIOR TO REMOVING THEM. ALL EXISTING PAVEMENT MARKINGS REMOVED DURING CONSTRUCTION SHALL BE REPLACED BY THE CONTRACTOR.
30. THE CONTRACTOR SHALL INSTALL A PREFORMED EXPANSION JOINT WHEN PROPOSED SIDEWALK IMPROVEMENTS ARE IMMEDIATELY ADJACENT TO AN EXISTING CONCRETE SLAB AND/OR BUILDING.
31. ALL CONCRETE SHALL DEVELOP A MINIMUM OF 3000 PSI COMPRESSIVE STRENGTH AT 28 DAYS, UNLESS OTHERWISE NOTED.
32. WHERE TRENCHING EXCEEDS 5 FEET IN DEPTH, THE EXCAVATION SHALL COMPLY WITH THE TRENCH SAFETY ACT AND THE OCCUPATIONAL SAFETY AND HEALTH ADMINISTRATION'S (OSHA) TRENCH EXCAVATION SAFETY STANDARDS, 29 C.F.R. 1926.650 SUBPART B, INCLUDING ALL SUBSEQUENT REVISIONS OR UPDATES TO THESE STANDARDS AS ADOPTED BY THE DEPARTMENT OF LABOR AND EMPLOYMENT SECURITY (DLES). THE CONTRACTOR SHALL CONSIDER ALL AVAILABLE GEOTECHNICAL INFORMATION IN HIS DESIGN OF THE TRENCH EXCAVATION SAFETY SYSTEM.
33. NO TRENCHES OR HOLES NEAR WALKWAYS, IN ROADWAYS OR THEIR SHOULDERS ARE TO BE LEFT OPEN DURING INACTIVE CONSTRUCTION HOURS WITHOUT THE WRITTEN PERMISSION OF THE CITY OF DORAL.
34. THE CONTRACTOR SHALL BE RESPONSIBLE FOR ENSURING THAT ALL CONSTRUCTION SHALL BE DONE IN A SAFE MANNER AND IN STRICT COMPLIANCE WITH ALL THE REQUIREMENTS OF THE FEDERAL OCCUPATIONAL SAFETY AND HEALTH ACT OF 1970, AS WELL AS, ALL STATE AND LOCAL SAFETY AND HEALTH REGULATIONS.
35. THE CONTRACTOR SHOULD TAKE SPECIAL NOTE OF SOIL CONDITIONS THROUGHOUT THIS PROJECT. ANY SPECIAL SHORING, SHEETING, OR OTHER PROCEDURES NECESSARY TO PROTECT ADJACENT PROPERTIES (PUBLIC OR PRIVATE) OR EXISTING UTILITIES DURING EXCAVATION OR BACKFILLING ACTIVITIES SHALL BE THE SOLE RESPONSIBILITY OF THE CONTRACTOR.
36. THE CONTRACTOR SHALL BE ADVISED THAT OTHER PROJECTS MAY BE UNDER CONSTRUCTION CONCURRENTLY WITH THIS PROJECT AND THAT COORDINATION EFFORTS MAY BE NECESSARY. THE CONTRACTOR SHALL BE RESPONSIBLE FOR DETERMINING THE CONSTRUCTION SCHEDULE AND INCLUDING THE AMOUNT OF COORDINATION WHICH MAY BE REQUIRED. ALL ASSOCIATED COSTS SHALL BE INCLUDED WITHIN THE CONTRACTOR'S BID.
37. REPLACE COMPLETE SIDEWALK FLAGS (NO PERMANENT PATCHING ALLOWED) PER FDOT INDEX 522-002
38. CONTRACTOR SHALL MAINTAIN MINIMUM PEDESTRIAN ACCESS ROUTE OF 48".
39. APPLY BITUMINOUS TACK COAT ON EXISTING PAVEMENT SURFACES AS PER FDOT STANDARD SPECIFICATIONS SECTION 300.

SURVEYOR'S NOTES

40. ELEVATIONS SHOWN ARE EXPRESSED IN US FEET AND REFER TO NATIONAL GEODETIC VERTICAL DATUM OF 1929 (NGVD 29).
41. BENCH MARK #M-105 LOCATOR NO. 3051 SW; ELEVATION IS 7.83 FEET OF N.G.V.D. OF 1929
42. BEARINGS AND COORDINATES ARE RELATIVE TO THE STATE PLANE COORDINATES, FLORIDA EAST ZONE NORTH AMERICAN DATUM (NAD 83/1980 HARN) ADJUSTMENTS.

DATE	DESCRIPTION	DATE	DESCRIPTION	MANUEL A. SAULEDA, P.E. P.E. LICENSE NUMBER 45988 H. W. LOCHNER, INC. CONSULTING ENGINEERS AND PLANNERS 8750 NW 36TH STREET - SUITE 360 MIAMI, FLORIDA - 33178	 CITY OF DORAL	SITE LOCATION VARIOUS LOCATIONS	 GENERAL NOTES	SHEET NO.
								3

CURVE DATA C1
 PI STA. = 10+83.72
 Δ = 3° 11' 50" (LT)
 D = 1° 54' 35"
 L = 827.740
 R = 3,000.00
 PC STA. = 10+00.00
 PT STA. = 11+67.40

CURVE DATA C2
 PI STA. = 13+19.31
 Δ = 5° 47' 51" (LT)
 D = 1° 54' 35"
 L = 151.91
 R = 303.56
 PC STA. = 10+00.00
 PT STA. = 14+70.96

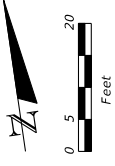

BEGIN SPEED TABLE PROJECT
 STA. 11+39.00 @ SURVEY NW 114th CT

END SPEED TABLE PROJECT
 STA. 13+61.00 @ SURVEY NW 114th CT

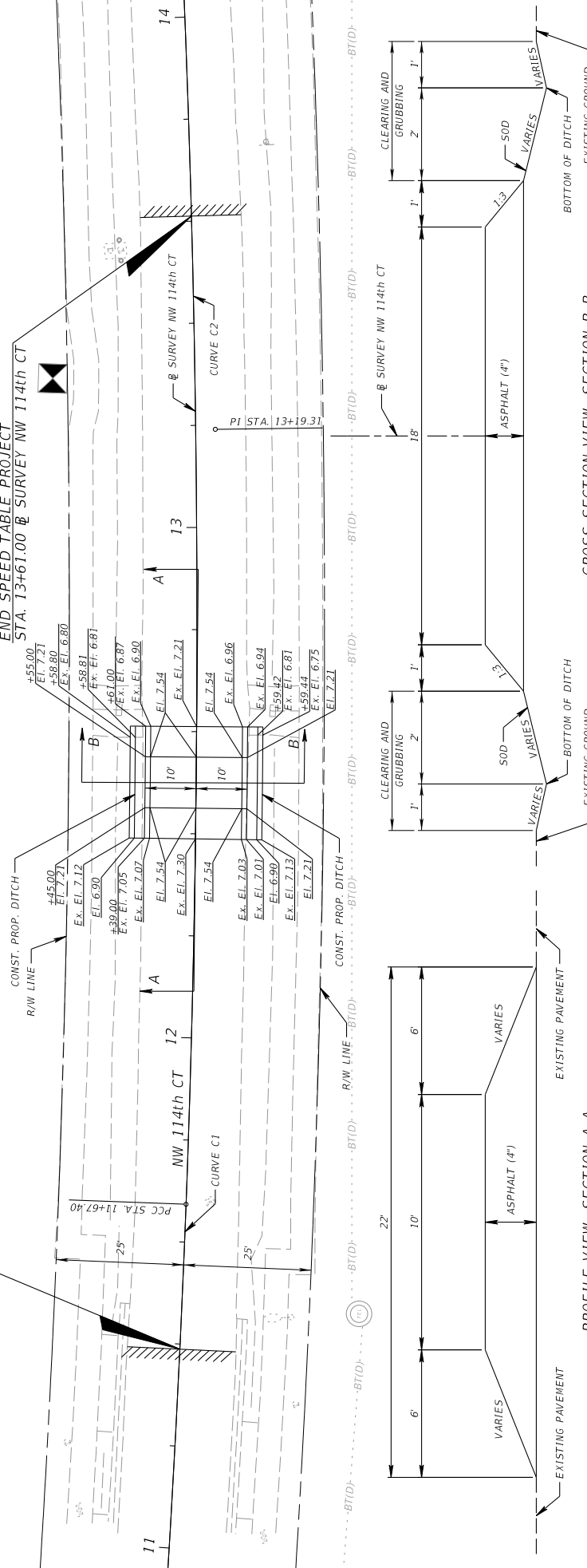

PROFILE VIEW, SECTION A-A
 ALONG CENTER OF ROADWAY
 N.T.S.

CROSS SECTION VIEW, SECTION B-B
 N.T.S.

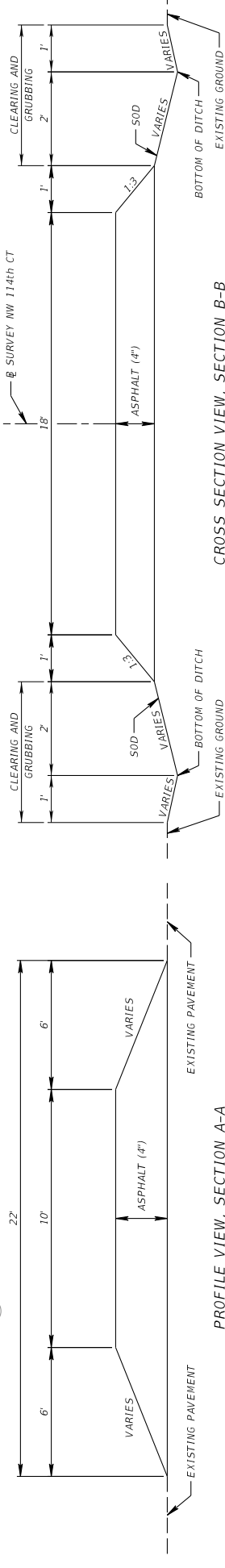

SPEED TABLE DETAILS

SPEED TABLE AT NW 114th CT
 BETWEEN NW 86th ST AND NW 87th LANE

DATE	DESCRIPTION	REVISIONS	DATE	DESCRIPTION

MANUEL A. SAUVEDA, P.E. P.E. LICENSE NUMBER 45988 H. W. LOCHNER, INC. CONSULTING ENGINEERS AND PLANNERS 8750 NW 36th STREET, SUITE 360 MIAMI, FLORIDA - 33176	CITY OF DORAL 	ROADWAY PLAN	SHEET NO. 5
--	--	--------------	----------------

ADOCUESADA 7/26/2023 4:28:47 PM DGB/BLT

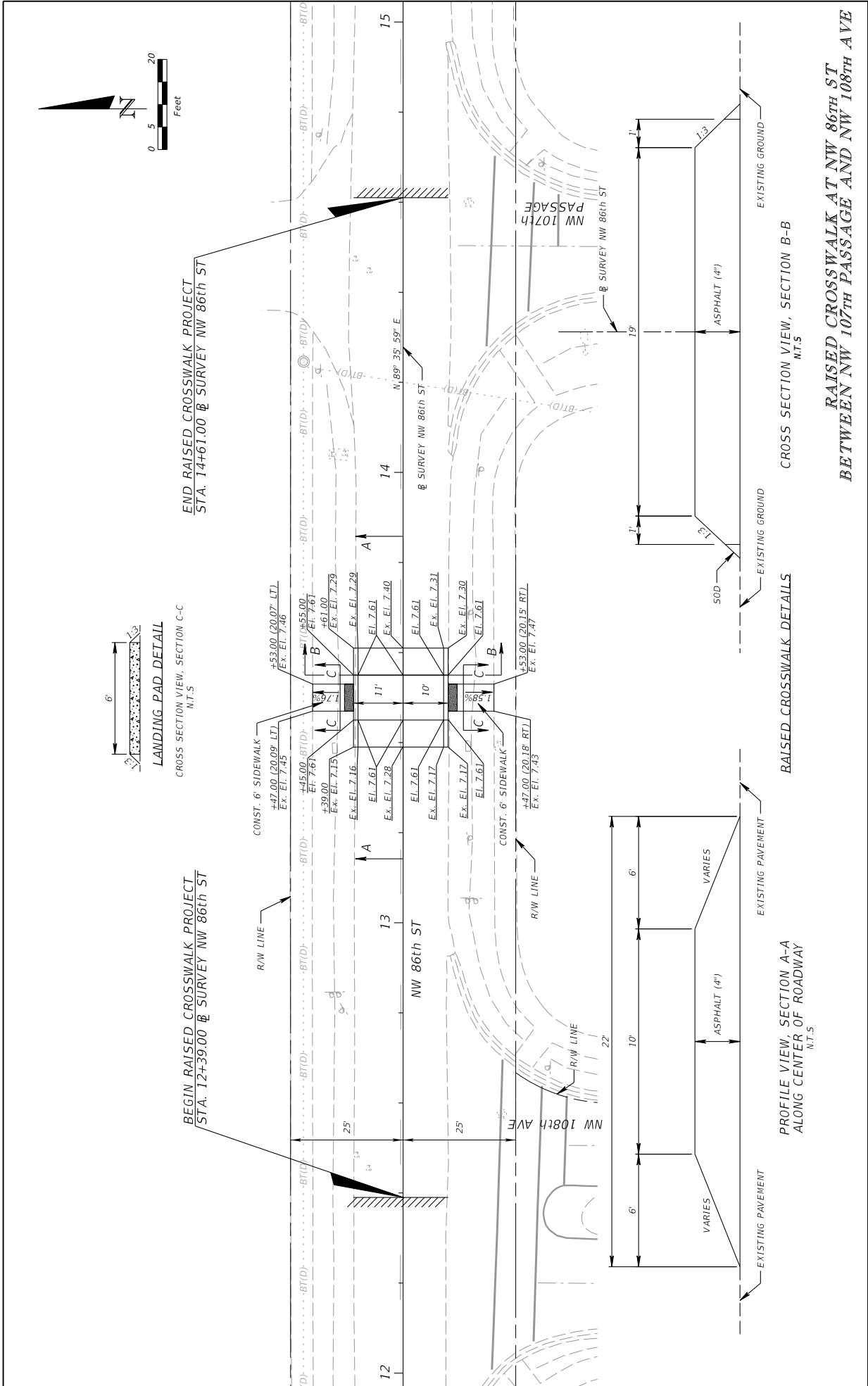

DATE	DESCRIPTION	REVISIONS	DATE	DESCRIPTION

MANUEL A. SAUVEDA, P.E. P.E. LICENSE NUMBER 45988 H. W. LOCHNER, INC. CONSULTING ENGINEERS AND PLANNERS 8750 NW 36th STREET - SUITE 360 MIAMI, FLORIDA - 33176		CITY OF DORAL  1/21/2022 3:40:17 PM Default	ROADWAY PLAN TRAFFIC CALMING DEVICES PROJECT VARIOUS LOCATIONS XSTAMS	SHEET NO. 6
---	--	---	--	-------------------

RAISED CROSSWALK AT NW 86th ST
BETWEEN NW 107th PASSAGE AND NW 108th AVE

CITY OF DORAL



*TRAFFIC CALMING IMPROVEMENTS: SECTION 7
SIGNING AND PAVEMENT MARKING PLANS*

INDEX OF SIGNING AND PAVEMENT MARKING PLANS

<u>SHEET NO.</u>	<u>SHEET DESCRIPTION</u>
S-1	KEY SHEET
S-2	TABULATION OF QUANTITIES
S-3	GENERAL NOTES
S-4 - S-8	SIGNING AND PAVEMENT MARKING PLAN
S-9	SERVICE POINT DETAIL
S-10	FEEDBACK SIGN DETAIL FOUNDATION SHEET

CITY COUNCIL

- MAYOR
CHRISTI FRAGA
- VICE MAYOR
RAFAEL PINEYRO
- COUNCILWOMAN
DIGNA CABRAL
- COUNCILWOMAN
MAUREEN PORRAS
- COUNCILMAN
OSCAR PUIG-CORVE
- PUBLIC WORKS DIRECTOR
CARLOS ARROYO

NOTE:
SCALE OF THESE PLANS MAY HAVE
CHANGED DUE TO REPRODUCTION

PLANS PREPARED FOR
CITY OF DORAL

BY

ENGINEER OF RECORD:

THESE PLANS HAVE BEEN PREPARED IN ACCORDANCE WITH AND ARE GOVERNED BY THE FLORIDA DEPARTMENT OF TRANSPORTATION, STANDARD PLANS 2019-2020, AND SPECIFICATIONS JULY 2019, FOR ROAD AND BRIDGE CONSTRUCTION AND MAINTENANCE FOR STREETS AND HIGHWAYS AS AMENDED BY CONTRACT DOCUMENTS, MIAMI-DADE COUNTY PUBLIC WORKS DEPARTMENT STANDARDS AND SPECIFICATIONS PART 1, 2, AND 3, THE MIAMI-DADE COUNTY PUBLIC WORKS DEPARTMENTS - HIGHWAY DIVISION STANDARD DETAILS.



MANUEL A. SAULEDA, P.E.
P.E. NO.: 45988
8750 N.W. 36TH STREET, SUITE 360
MIAMI, FLORIDA 33178
TEL: (305) 503-9873; FAX: (305) 503-9882

Manuel A Sauleda
2023.09.19
11:41:46-04'00'

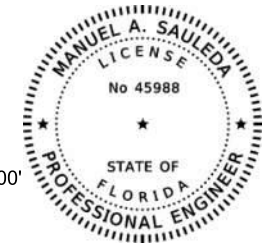

MANUEL A. SAULEDA
FLORIDA REGISTRATION P.E., NO. 45988

SHEET
NO.

S-1

TABULATION OF QUANTITIES

PAY ITEM NO.	DESCRIPTION	UNIT	SHEET NUMBERS														TOTAL THIS SHEET		GRAND TOTAL	
			S-4		S-5		S-6		S-7		S-8		PLAN	FINAL	PLAN	FINAL	PLAN	FINAL		
			PLAN	FINAL	PLAN	FINAL	PLAN	FINAL	PLAN	FINAL	PLAN	FINAL	PLAN	FINAL	PLAN	FINAL	PLAN	FINAL		
110-4-10	REMOVAL OF EXISTING CONCRETE	SY			36		14										50		50	
522-1	CONCRETE SIDEWALK 4"	SY			36		14										50		50	
630-2-12	CONDUIT, FURNISH & INSTALL, DIRECTIONAL BORE	LF			1331		1495										2826		2826	
635-2-11	PULL & SPLICE BOX, F&I, 13" x 24" COVER SIZE	EA			29		23										52		52	
639-1-122	ELECTRICAL POWER SERVICE, F&I, UNDERGROUND, METER PURCHASE BY CONTRACTOR	AS			6		4										10		10	
639-2-1	ELECTRICAL SERVICE WIRE, FURNISH & INSTALL	LF			1480		1648										3128		3128	
639-3-11	ELECTRICAL SERVICE DISCONNECT, F&I, POLE MOUNT	EA			6		4										10		10	
641-2-12	PRESTRESSED CONCRETE POLE, F&I, TYPE P-11 SERVICE POLE	EA			6		4										10		10	
700-1-11	SINGLE POST SIGN, F&I GROUND MOUNT, UP TO 12 SF	AS	6						2		6						14		14	
700-1-60	SINGLE POST SIGN, REMOVE	AS			1		2										3		3	
700-11-131	ELECTRONIC DISPLAY SIGN, F&I GROUND MOUNT - AC POWERED, SPEED FEEDBACK SIGN, UP TO 12 SF	AS			6		4										10		10	
706-1-3	RAISED PAVEMENT MARKERS, TYPE B	EA							12		12						24		24	
711-11-123	THERMOPLASTIC, STANDARD, WHITE, SOLID, 12" FOR CROSSWALK AND ROUNDABOUT	LF							152		148						300		300	
711-11-125	THERMOPLASTIC, STANDARD, WHITE, SOLID, 24" FOR STOP LINE AND CROSSWALK	LF									70						70		70	
711-16-201	THERMOPLASTIC, STANDARD-OTHER SURFACES, YELLOW, SOLID, 6"	GM							0.010		0.076						0.086		0.086	
711-16-231	THERMOPLASTIC, STANDARD-OTHER SURFACES, YELLOW, SKIP, 6"	GM									0.030						0.030		0.030	

PAY ITEM NOTES:
 706-1-3: YELLOW/YELLOW RPMs
 700-11-231: INCLUDES REGULATORY SIGN PANEL

REVISIONS DESCRIPTION DATE DESCRIPTION		MANUEL A. SAULEDA, P.E. P.E. LICENSE NUMBER 45988 H. W. LOCHNER, INC. CONSULTING ENGINEERS AND PLANNERS 8750 NW 36th STREET - SUITE 360 MIAMI, FLORIDA - 33178	TRAFFIC CALMING DEVICES PROJECT VARIOUS LOCATIONS	CITY OF DORAL 	SHEET NO. S-2
---	--	---	--	--	------------------

THE OFFICIAL RECORD OF THIS SHEET IS THE ELECTRONIC FILE DIGITALLY SIGNED AND SEALED UNDER RULE 61G15-23.004, F. A. C.

SIGNING & PAVEMENT MARKINGS NOTES

1. DISTANCES AND DESCRIPTIONS FOR ADVANCED WARNING MARKINGS ARE RECIPROCAL ON BOTH SIDES.
2. REFER TO 2009 MUTCD, FIGURE 3B-30, FIGURE 3B-31, AND FDOT STADARD PLANS INDEX 711-001 FOR RAISED CROSSWALK AND ADVANCED WARNING MARKINGS.
3. HEIGHT AND LATERAL OFFSETS FOR ALL SINGLE COLUMN SIGNS SHALL BE PLACED IN ACCORDANCE TO FDOT STANDARD PLANS INDEX 700-010 AND INDEX 700-101.
4. ALL EXISTING SIGNS TO REMAIN.

REVISIONS				MANUEL A. SAULEDA, P.E. P.E. LICENSE NUMBER 45988 H. W. LOCHNER, INC. CONSULTING ENGINEERS AND PLANNERS 8750 NW 36th STREET - SUITE 360 MIAMI, FLORIDA - 33178	SITE LOCATION NW 82nd ST AND NW 114th AVE	CITY OF DORAL 	GENERAL NOTES	SHEET NO.
DATE	DESCRIPTION	DATE	DESCRIPTION					S-3

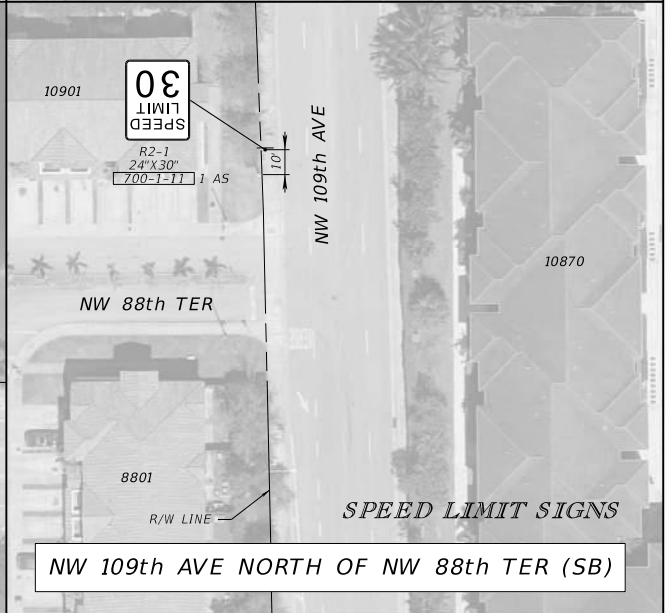
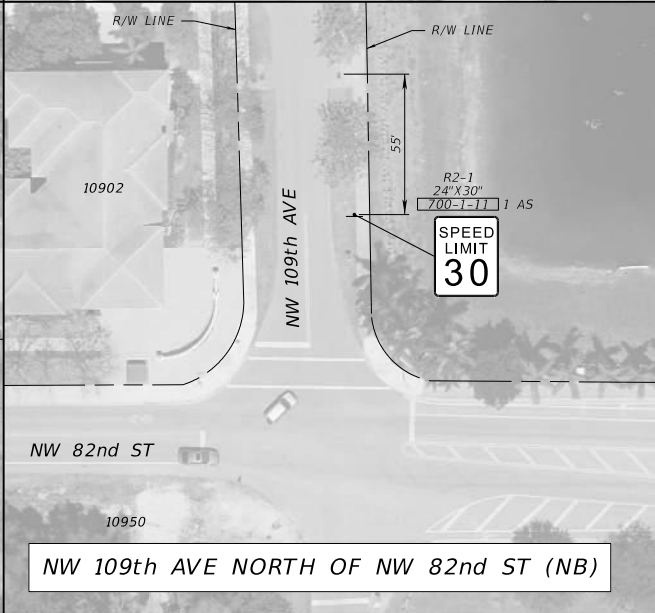
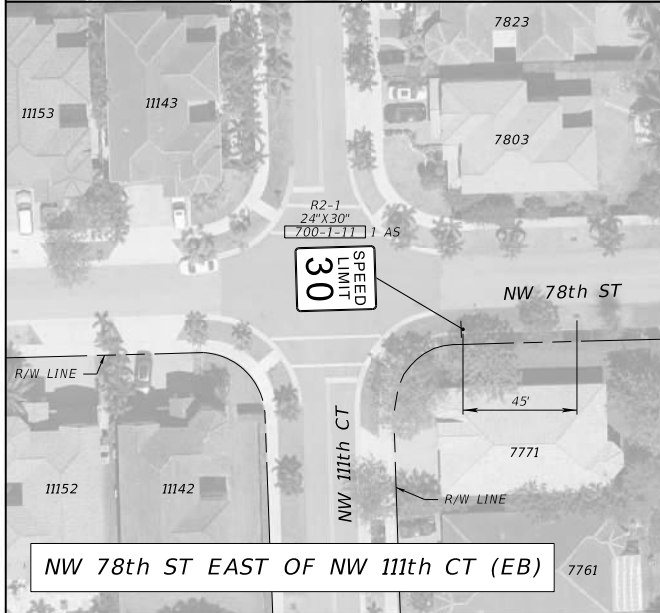
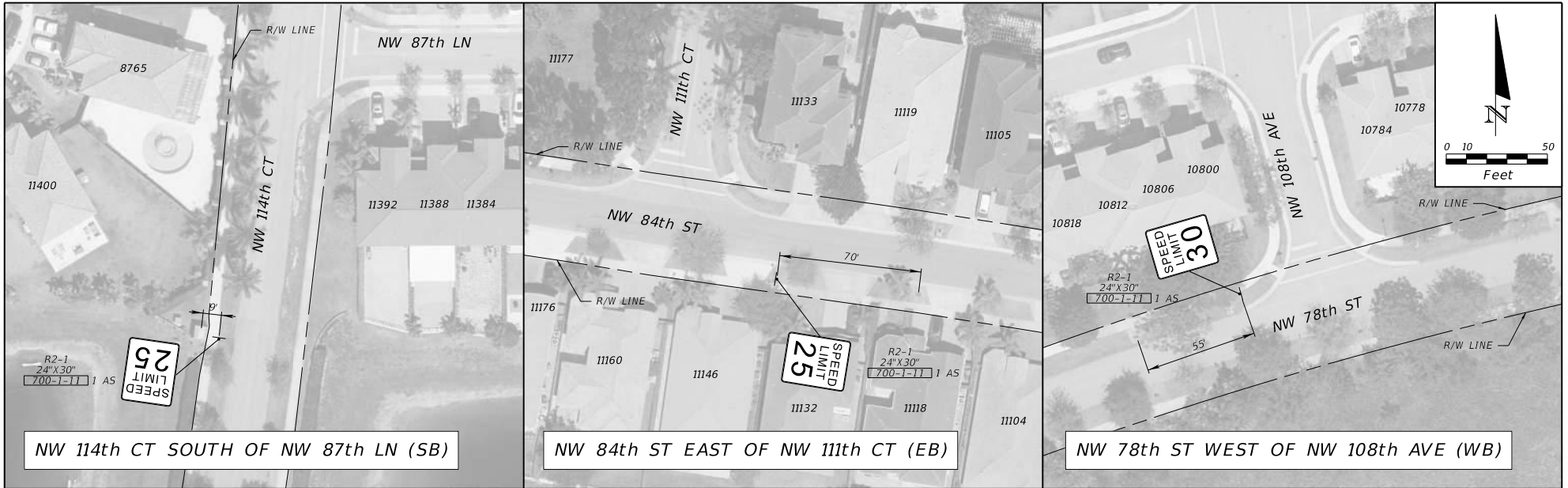

REVISIONS			
DATE	DESCRIPTION	DATE	DESCRIPTION

MANUEL A. SAULEDA, P.E.
 P.E. LICENSE NUMBER 45988
 H. W. LOCHNER, INC.
 CONSULTING ENGINEERS AND PLANNERS
 8750 NW 36th STREET - SUITE 360
 MIAMI, FLORIDA - 33178

**TRAFFIC CALMING
 DEVICES PROJECT**
 VARIOUS
 LOCATIONS

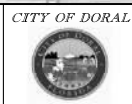

**SIGNING AND PAVEMENT
 MARKING PLAN**

SHEET
 NO.
 S-4

THE OFFICIAL RECORD OF THIS SHEET IS THE ELECTRONIC FILE DIGITALLY SIGNED AND SEALED UNDER RULE 61G15-23.004, F.A.C.

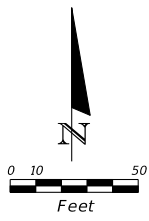
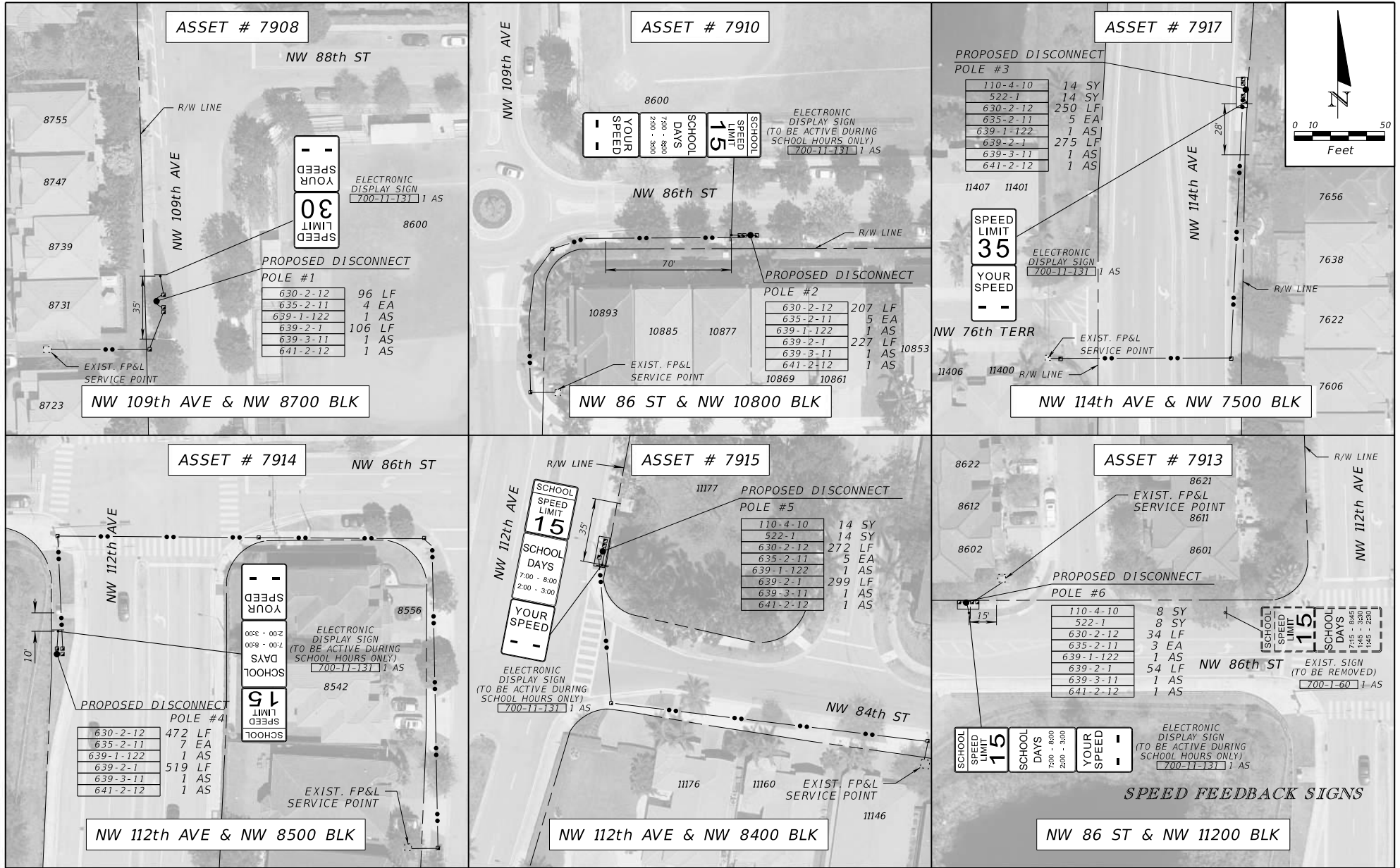

REVISIONS	
DATE	DESCRIPTION

MANUEL A. SAULEDA, P.E.
 P.E. LICENSE NUMBER 45988
 H. W. LOCHNER, INC.
 CONSULTING ENGINEERS AND PLANNERS
 8750 NW 36th STREET - SUITE 360
 MIAMI, FLORIDA - 33178

TRAFFIC CALMING DEVICES PROJECT
 VARIOUS LOCATIONS

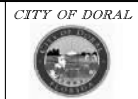

SIGNING AND PAVEMENT MARKING PLAN
 SHEET NO. S-5

THE OFFICIAL RECORD OF THIS SHEET IS THE ELECTRONIC FILE DIGITALLY SIGNED AND SEALED UNDER RULE 61G15-23.004, F.A.C.

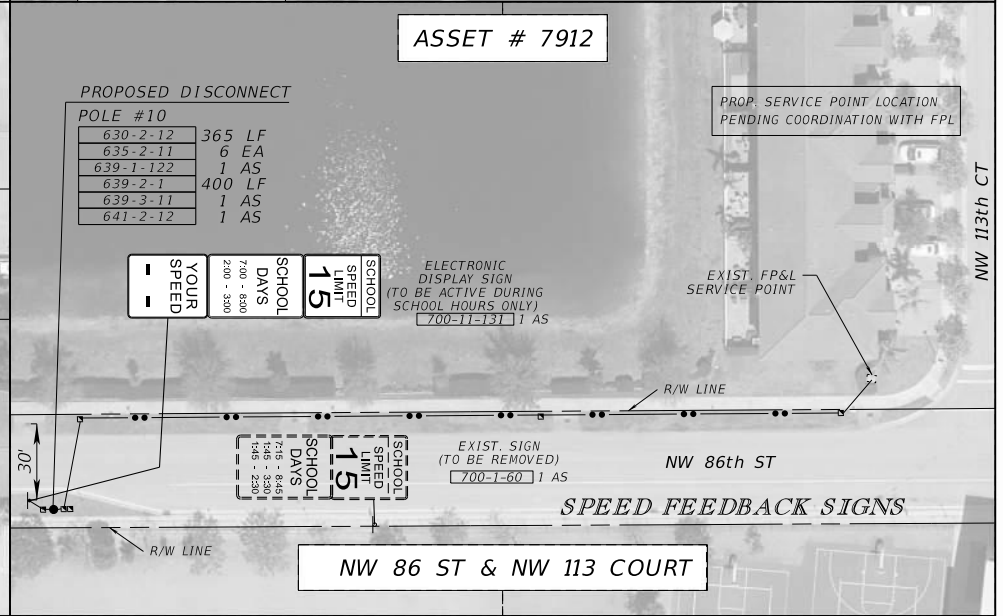
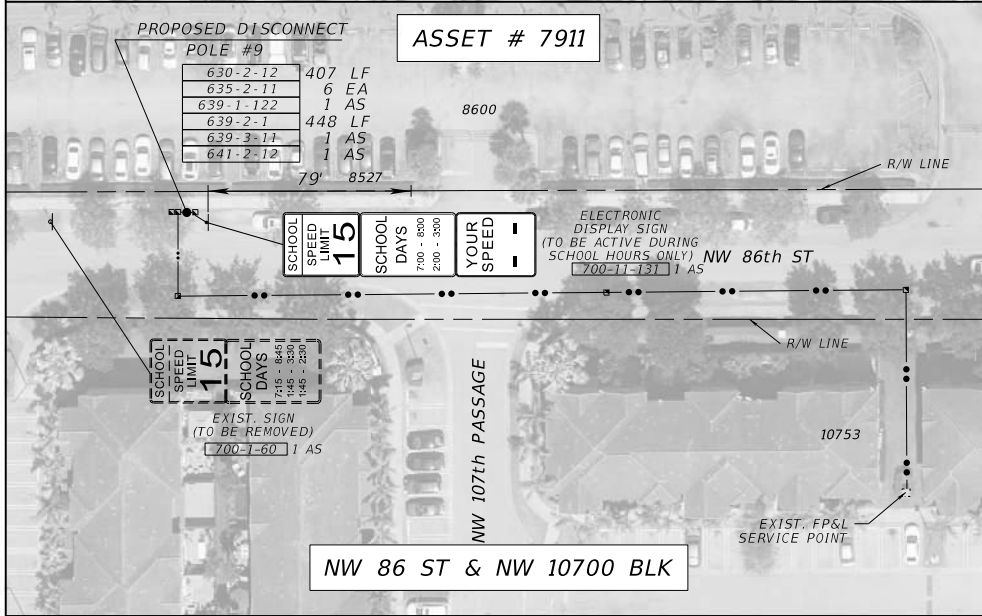
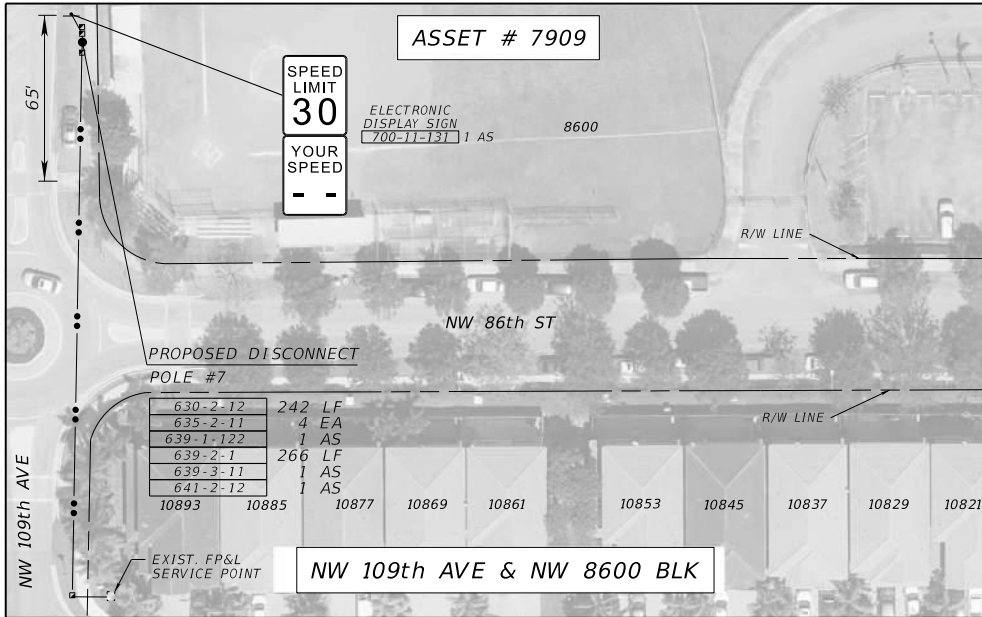

REVISIONS				MANUEL A. SAULEDA, P.E. P.E. LICENSE NUMBER 45988 H. W. LOCHNER, INC. CONSULTING ENGINEERS AND PLANNERS 8750 NW 36th STREET - SUITE 360 MIAMI, FLORIDA - 33178	TRAFFIC CALMING DEVICES PROJECT VARIOUS LOCATIONS	CITY OF DORAL	SHEET NO. S-6
DATE	DESCRIPTION	DATE	DESCRIPTION				

THE OFFICIAL RECORD OF THIS SHEET IS THE ELECTRONIC FILE DIGITALLY SIGNED AND SEALED UNDER RULE 61G15-23.004, F.A.C.

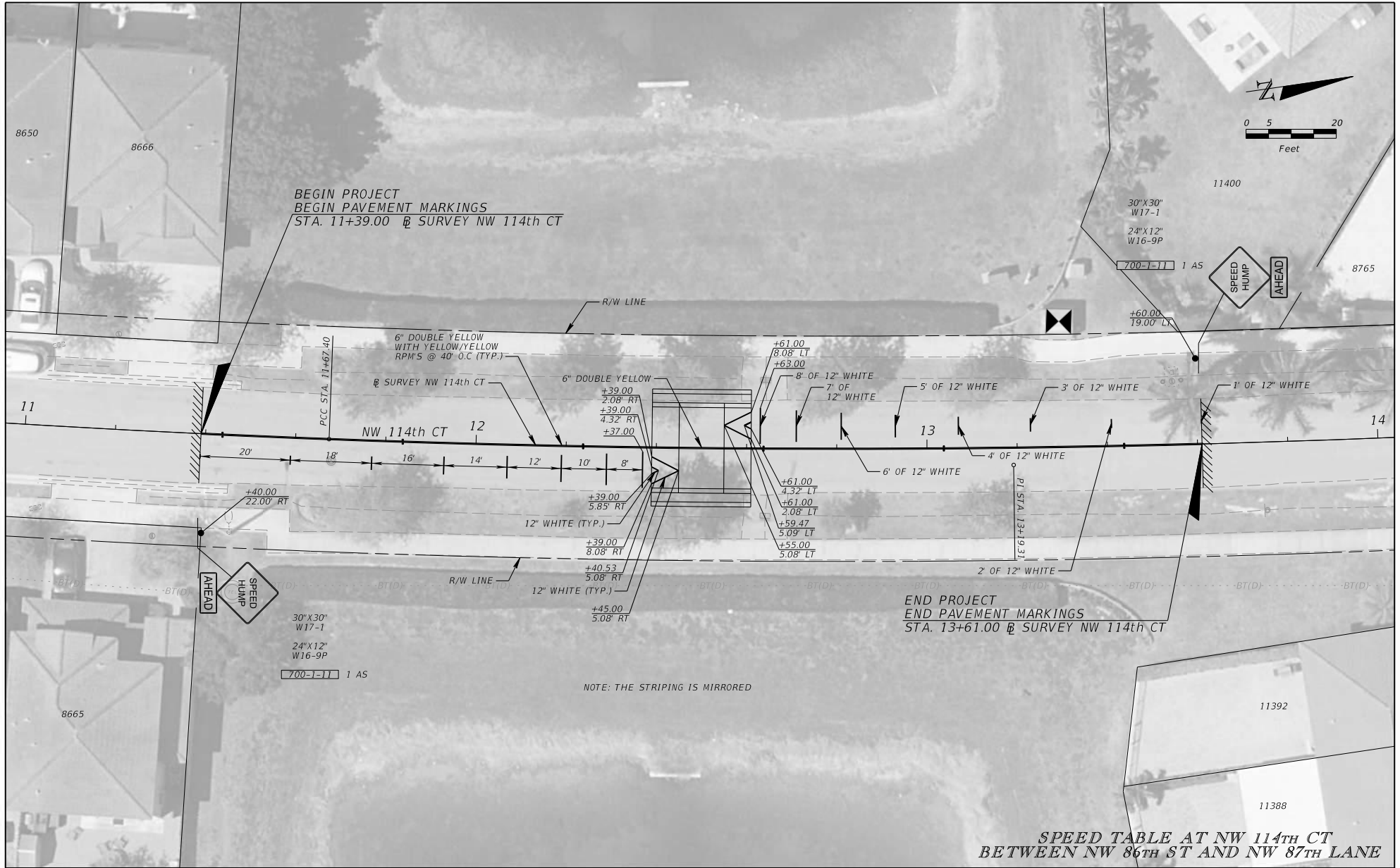

**SPEED TABLE AT NW 114TH CT
BETWEEN NW 86TH ST AND NW 87TH LANE**

REVISIONS		DESCRIPTION		MANUEL A. SAULEDA, P.E. P.E. LICENSE NUMBER 45988 H. W. LOCHNER, INC. CONSULTING ENGINEERS AND PLANNERS 8750 NW 36th STREET - SUITE 360 MIAMI, FLORIDA - 33178	TRAFFIC CALMING DEVICES PROJECT VARIOUS LOCATIONS	CITY OF DORAL 	SIGNING AND PAVEMENT MARKING PLAN	SHEET NO. S-7
DATE	DESCRIPTION	DATE	DESCRIPTION					

THE OFFICIAL RECORD OF THIS SHEET IS THE ELECTRONIC FILE DIGITALLY SIGNED AND SEALED UNDER RULE 61G15-23.004, F.A.C.

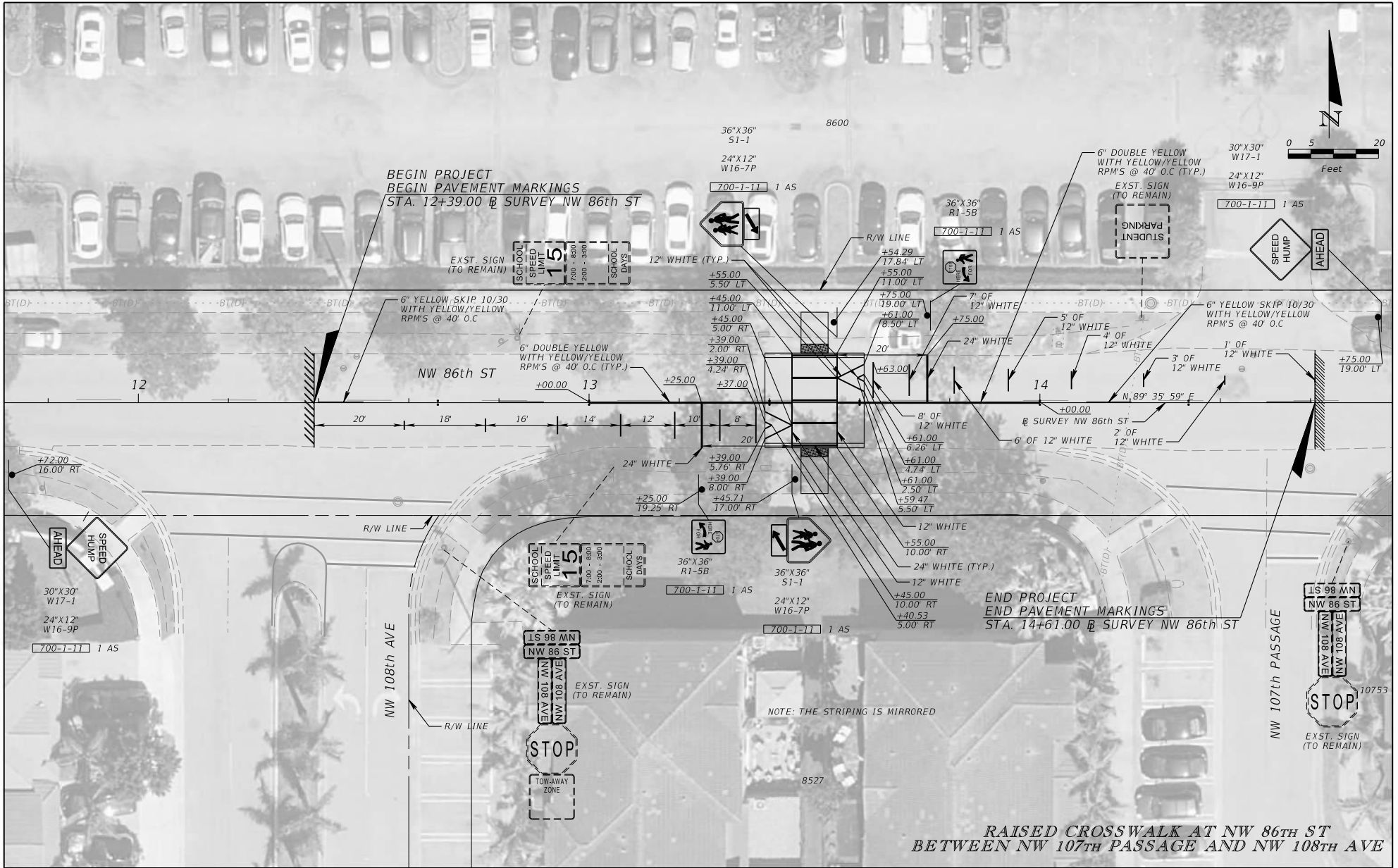

REVISIONS				MANUEL A. SAULEDA, P.E. P.E. LICENSE NUMBER 45988 H. W. LOCHNER, INC. CONSULTING ENGINEERS AND PLANNERS 8750 NW 36th STREET - SUITE 360 MIAMI, FLORIDA - 33178	TRAFFIC CALMING DEVICES PROJECT VARIOUS LOCATIONS	CITY OF DORAL 	SIGNING AND PAVEMENT MARKING PLAN	SHEET NO. S-8
DATE	DESCRIPTION	DATE	DESCRIPTION					

THE OFFICIAL RECORD OF THIS SHEET IS THE ELECTRONIC FILE DIGITALLY SIGNED AND SEALED UNDER RULE 61G15-23.004, F.A.C.

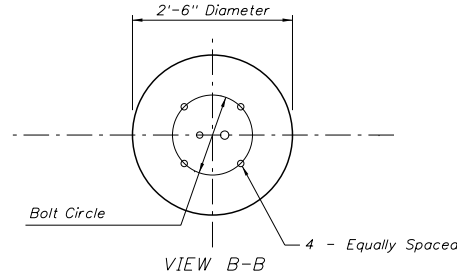
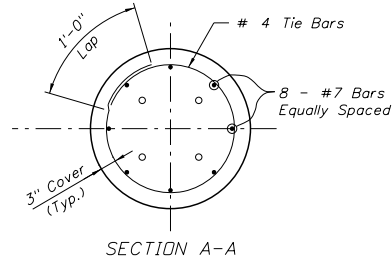

Anchor Bolts supplied by Transformer Base Manufacturer. Install per Manufacturer's recommendations.

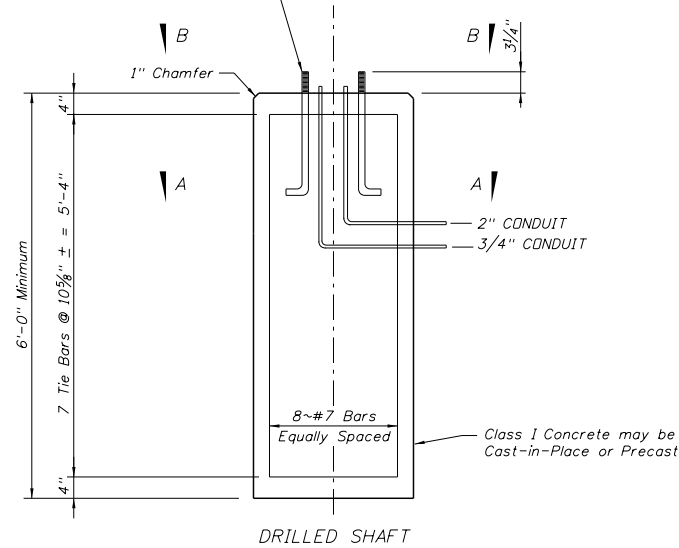

NOTES:

1. Design Wind Speed 150 MPH.
2. Aluminum: Aluminum tube shall meet the requirements of aluminum Association Alloy 6061-t-6 (ASTM B221).
3. Concrete: Class I
4. Reinforcing Steel: ASTM A615 Grade 60.
5. Foundation Design was based on the following soil criteria:
 Classification= Cohesionless (fine sand)
 Friction Angle= 30 Degrees (30°)
 Unit Weight= 50 lbs./cu ft. (assumed saturated)
6. The contractor shall construct concrete slabs around all pullboxes located in unpaved/grass area. See Index 17500 for details and notes. Cost of the slab construction shall be included in pay item for pullboxes.

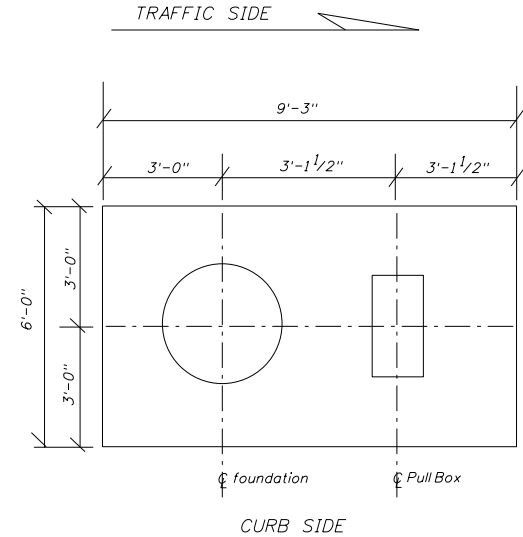

CONCRETE SLAB DETAIL
N.T.S.

REVISIONS		DATE	DESCRIPTION

MANUEL A. SAULEDA, P.E.
 P.E. LICENSE NUMBER 45988
 H. W. LOCHNER, INC.
 CONSULTING ENGINEERS AND PLANNERS
 8750 NW 36th STREET - SUITE 360
 MIAMI, FLORIDA - 33178

**TRAFFIC CALMING
 DEVICES PROJECT**
 VARIOUS
 LOCATIONS

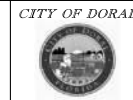

**FEEDBACK SIGN DETAIL
 FOUNDATION SHEET**

SHEET
 NO.
 S-10

Date: 10/2/2023

**City of Doral
Speed Feedback Signs
Final Cost Estimate**

SIGNING AND PAVEMENT MARKING					
Pay Item	Description	Unit	Quantity	Unit Cost	Total
ROADWAY					
110-4-10	REMOVAL OF EXISTING CONCRETE (ASSET #7917)	SY	14.0	\$32.83	\$459.62
522-1	CONCRETE SIDEWALK 4" (ASSET #7917)	SY	14.0	\$71.50	\$1,001.00
Roadway Subtotal:					\$1,460.62
SIGNING AND PAVEMENT MARKING					
630-2-12	CONDUIT, FURNISH & INSTALL, DIRECTIONAL BORE	LF	2653.0	\$43.82	\$116,254.46
632-7-1	SIGNAL CABLE- NEW OR RECONSTRUCTED INTERSECTION, FURNISH & INSTALL	LF	2893.0	\$18.78	\$54,330.54
635-2-11	PULL & SPLICE BOX, F&I, 13" x 24" COVER SIZE	EA	49.0	\$1,620.58	\$79,408.42
639-1-122	ELECTRICAL POWER SERVICE, F & I , UNDERGROUND, METER PURCHASE BY CONTRACTOR	AS	10.0	\$7,689.88	\$76,898.80
639-3-11	ELECTRICAL SERVICE DISCONNECT, F&I, POLE MOUNT	AS	10.0	\$4,113.27	\$41,132.70
641-2-12	PRESTRESSED CONCRETE POLE, F&I, TYPE P-11 SERVICE POLE	AS	10.0	\$3,106.32	\$31,063.20
*700-11-162	ELECTRONIC DISPLAY SIGN, FURNISH & INSTALL GROUND MOUNT- AC POWERED, SPEED FEEDBACK W/FLASHING BEACON, 12-20 SF	AS	10.0	\$17,629.38	\$176,293.80
Signing and Pavement Marking Subtotal:					\$575,381.92
8% Mobilization:					\$46,147.40
10% Maintenance of Traffic:					\$57,684.25
Subtotal + 8% Mob. + 10% MOT					\$680,674.20
Contingency (15%)					\$102,101.13
Grand Total					\$782,775.33

Date: 10/2/2023

**City of Doral
Speed Limit Signs
Final Cost Estimate**

SIGNING AND PAVEMENT MARKING					
Pay Item	Description	Unit	Quantity	Unit Cost	Total
700-1-11	SINGLE POST SIGN, F & I GROUND MOUNT, UP TO 12 SF	AS	6.0	\$559.58	\$3,357.48
700-1-60	SINGLE POST SIGN REMOVAL	AS	6.0	\$44.26	\$265.56
Subtotal:					\$3,623.04
8% Mobilization:					\$289.84
10% Maintenance of Traffic:					\$362.30
Subtotal + 8% Mob. + 10% MOT					\$4,275.19
Contingency (15%)					\$641.28
Grand Total					\$4,916.47

Date: 10/2/2023

**City of Doral
Raised Crossing
Final Cost Estimate**

Pay Item	Description	Unit	Quantity	Unit Cost	Total
ROADWAY					
110-1-10	CLEARING AND GRUBBING	AC	0.0024	\$60,056.73	\$144.14
110-4-10	REMOVAL OF EXISTING CONCRETE	SY	17.1	\$32.83	\$560.08
334-1-53	SUPERPAVE ASPHALTIC CONCRETE, TRAFFIC C, PG 76-22	TN	9.00	\$272.24	\$2,450.16
522-2	CONCRETE SIDEWALK AND DRIVEWAYS, 6" THICK	SY	13.0	\$90.67	\$1,178.71
527-2	DETECTACLE WARNINGS	SF	25.0	\$39.34	\$983.50
570-1-3	PERFORMANCE TURF, SOD AND SOIL, SHOULDER TREATMENT INDEX 570-010	SY	18.0	\$12.08	\$217.44
Roadway Subtotal:					\$5,534.03
SIGNING AND PAVEMENT MARKING					
700-1-11	SINGLE POST SIGN, F & I GROUND MOUNT, UP TO 12 SF	AS	6.0	\$559.58	\$3,357.48
706-1-3	RAISED PAVEMENT MARKERS, TYPE B WITHOUT FINAL SURFACE MARKINGS	EA	12.0	\$4.83	\$57.96
711-11-123	THERMOPLASTIC, STANDARD, WHITE, SOLID, 12" FOR CROSSWALK AND ROUNDABOUT	LF	148.0	\$2.92	\$432.16
711-11-125	THERMOPLASTIC, STANDARD, WHITE, SOLID, 24" STOP LINE AND CROSSWALK	LF	70.0	\$6.11	\$427.70
711-16-201	THERMOPLASTIC STANDARD-OTHER SURFACES, YELLOW, SOLID, 6"	GM	0.08	\$6,480.48	\$492.52
711-16-231	THERMOPLASTIC STANDARD-OTHER SURFACES, YELLOW, SKIP, 6"	GM	0.03	\$2,271.01	\$68.13
Signing and Pavement Marking Subtotal:					\$4,835.95
8% Mobilization:					\$829.60
10% Maintenance of Traffic:					\$1,037.00
Subtotal + 8% Mob. + 10% MOT					\$12,236.57
Contingency (15%)					\$1,835.49
Grand Total					\$14,072.05

Note: Unit Cost was obtained from Area 13 Current 12 Month Moving Average from 2022/09/01 to 2023/08/31

**City of Doral
Speed Table
Final Cost Estimate**

Pay Item	Description	Unit	Quantity	Unit Cost	Total
ROADWAY					
110-1-10	CLEARING AND GRUBBING	AC	0.0040	\$60,056.73	\$240.23
334-1-53	SUPERPAVE ASPHALTIC CONCRETE, TRAFFIC C, PG 76-22	TN	9.00	\$272.24	\$2,450.16
570-1-3	PERFORMANCE TURF, SOD AND SOIL, SHOULDER TREATMENT INDEX 570-010	SY	15.0	\$12.08	\$181.20
Roadway Subtotal:					\$2,871.59
SIGNING AND PAVEMENT MARKING					
700-1-11	SINGLE POST SIGN, F & I GROUND MOUNT, UP TO 12 SF	AS	2.0	\$559.58	\$1,119.16
706-1-3	RAISED PAVEMENT MARKERS, TYPE B WITHOUT FINAL SURFACE MARKINGS	EA	12.0	\$4.83	\$57.96
711-11-123	THERMOPLASTIC, STANDARD, WHITE, SOLID, 12" FOR CROSSWALK AND ROUNDABOUT	LF	152.0	\$2.92	\$443.84
711-16-201	THERMOPLASTIC STANDARD-OTHER SURFACES, YELLOW, SOLID, 6"	GM	0.01	\$6,480.48	\$64.80
Signing and Pavement Marking Subtotal:					\$1,685.76
8% Mobilization:					\$364.59
10% Maintenance of Traffic:					\$455.74
Subtotal + 8% Mob. + 10% MOT					\$5,377.68
Contingency (15%)					\$806.65
Grand Total					\$6,184.33

Note: Unit Cost was obtained from Area 13 Current 12 Month Moving Average from 2022/09/01 to 2023/08/31